

AM3186 – Filter Bank

6 to 26.5 GHz Bandpass Filter Bank

Description

AM3186 is a sub-octave fixed bandpass filter bank covering the 6 GHz to 26.5 GHz frequency range. The filter bank contains 5 bandpass filters with full 1 GHz overlap as well as an integrated, low-loss filter bypass path. AM3186 is an excellent front-end filter bank for a broadband receiver, or transmitter. AM3186 is packaged in a 5mm QFN package and operates over the -40C to +85C temperature range.

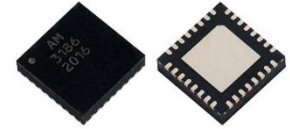

Features

- Sub-Octave Filter Bank
- Integrated Switches
- Integrated Control Line Filtering
- 6 dB Insertion Loss
- 20 GHz Bypass Path
- +36 dBm IIP3
- +5.0 V Supply
- +3.3 to +5.0 V Control
- -40C to +85C Operation
- 5mm QFN package

Functional Diagram

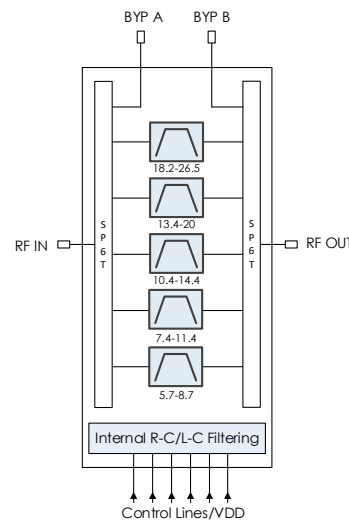

Characteristic Performance

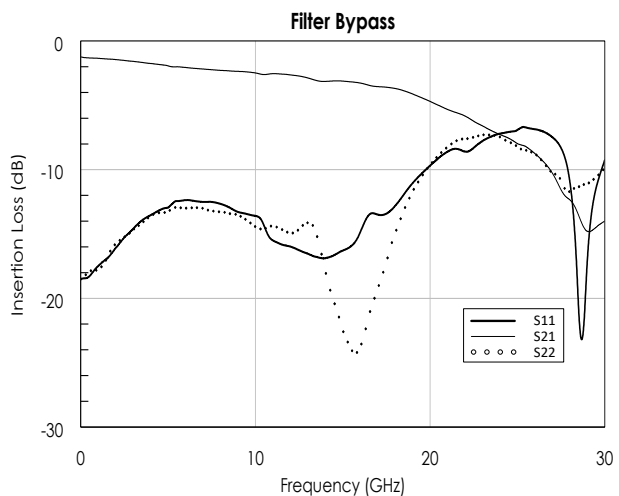
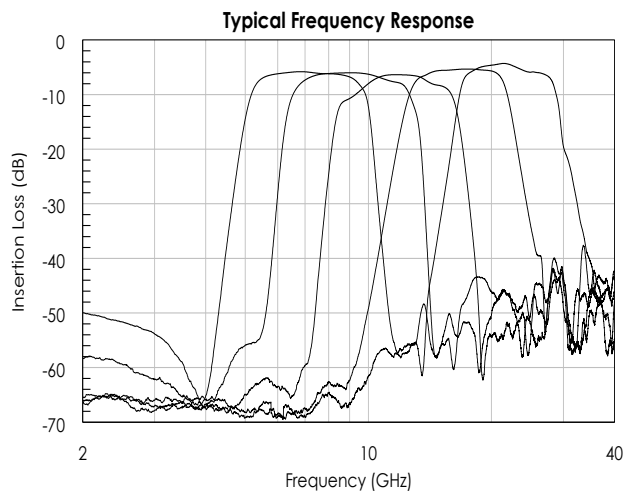

Table of Contents

.....	1	Recommended Operating Conditions ...	4
Description	1	DC Electrical Characteristics	5
Features	1	RF Performance	5
Functional Diagram	1	Timing Characteristics	5
Characteristic Performance	1	State Table	5
Revision History	2	Typical Performance	6
Pin Layout and Definitions	3	Typical Application	9
Specifications	4	Evaluation PC Board	10
Absolute Maximum Ratings	4	Related Parts	10
Handling Information	4	Component Compliance Information	11

Revision History

Date	Revision Number	Notes
June 10, 2020	1	Initial Release
June 15, 2021	2	Updated figures and picture

AM3186 – Filter Bank

6 to 26.5 GHz Bandpass Filter Bank

Pin Layout and Definitions

Note: All Non-Named Pins are GND

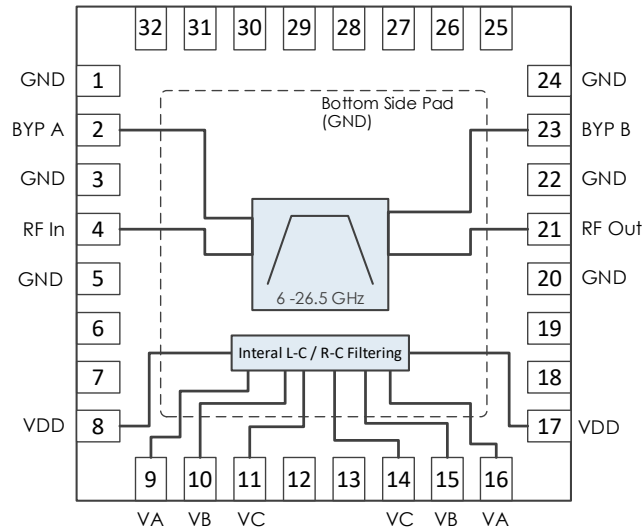

Pin Number	Pin Name	Pin Function
1	GND	Ground – Common
2	BYP A	Filter Bypass A Side – 50 Ohms – DC Coupled, External DC Blocking Cap Required
3	GND	Ground – Common
4	RF In	RF Input – 50 Ohms – DC Coupled, External DC Blocking Cap Required
5-7	GND	Ground – Common
8	VDD	DC Power Input
9	VA	Switch Control A*
10	VB	Switch Control B**
11	VC	Switch Control C***
12, 13	GND	Ground – Common
14	VC	Switch Control C***
15	VB	Switch Control B**
16	VA	Switch Control A*
17	VDD	DC Power Input
18-20	GND	Ground – Common
21	RF Out	RF Output – 50 Ohms – DC Coupled, External DC Blocking Cap Required
22	GND	Ground – Common
23	BYP B	Filter Bypass B Side – 50 Ohms – DC Coupled, External DC Blocking Cap Required
24-32	GND	Ground – Common
Bottom Pad	GND	Ground – Common

* Pins 9 and 16 can be directly connected on board
 ** Pins 10 and 15 can be directly connected on board
 *** Pins 11 and 14 can be directly connected on board

AM3186 – Filter Bank

6 to 26.5 GHz Bandpass Filter Bank



Specifications

Absolute Maximum Ratings

	Minimum	Maximum
Supply Voltage	-0.3 V	+6.0 V
RF Input Power		+27 dBm
Operating Junction Temperature	-40 C	+150 C
Storage Temperature Range	-50 C	+150 C

Note: Any device operation beyond the Absolute Maximum Ratings may result in permanent damage to the device. The values listed in this table are extremes and do not imply functional operation of the device at these or any other conditions beyond what is listed under Recommended Operating Conditions. Any part subjected to conditions outside of what is recommended for an extended amount of time may suffer from reliability concerns.

Handling Information

	Minimum	Maximum
Storage Temperature Range (Recommended)	-50 C	+125 C
Moisture Sensitivity Level	MSL 3	



Atlanta Micro products are electrostatic sensitive.
Follow safe handling practices to avoid damage

Recommended Operating Conditions

	Minimum	Typical	Maximum
Supply Voltage	+3.0 V	+5.0 V	+5.2 V
Operating Case Temperature	-40 C		+85 C
Operating Junction Temperature	-40 C		+125 C

AM3186 – Filter Bank

6 to 26.5 GHz Bandpass Filter Bank

DC Electrical Characteristics

(T = 25 °C unless otherwise specified)

Parameter	Testing Conditions	Minimum	Typical	Maximum
DC Supply Voltage		+3.0 V	+5.0 V	+5.2 V
DC Supply Current	VDD = +5.0 V		18 mA	
Power Dissipated	VDD = +5.0 V		90 mW	
Logic Level Low		-0.1 V		+0.5 V
Logic Level High		+2.0 V		+VDD V

RF Performance

(T = 25 °C unless otherwise specified)

Parameter	Testing Conditions	Minimum	Typical	Maximum
Frequency Range		6 GHz		26.5 GHz
Insertion Loss	VDD = +5.0 V, Band 1		-6 dB	
	VDD = +5.0 V, Band 2		-6.3 dB	
	VDD = +5.0 V, Band 3		-6.5 dB	
	VDD = +5.0 V, Band 4		-5.5 dB	
	VDD = +5.0 V, Band 5		-5 dB	
Return Loss	VDD = +5.0 V		< -10 dB	
Input IP3	VDD = +5.0 V		+36 dBm	

Timing Characteristics

Parameter	Minimum	Typical	Maximum
Band Switching Speed		200 ns	

Note: Timing characteristics measured from 50% control to 90% RF.

State Table

VC	VB	VA	Filter Band
L	L	L	Bypass Enabled
L	L	H	5.7 – 8.7 GHz
L	H	L	7.4 – 11.4 GHz
L	H	H	10.4 – 14.4 GHz
H	L	L	13.4 – 20 GHz
H	L	H	18.2 – 26.5 GHz

AM3186 – Filter Bank

6 to 26.5 GHz Bandpass Filter Bank

Typical Performance

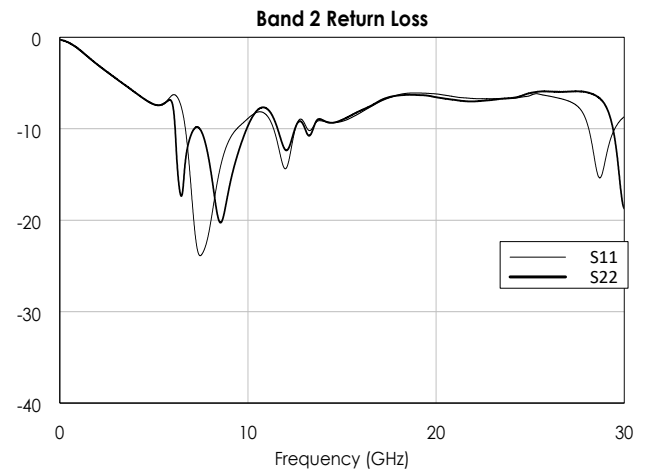
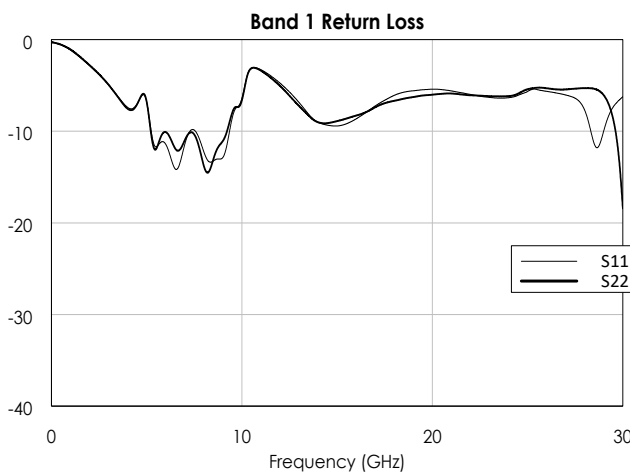
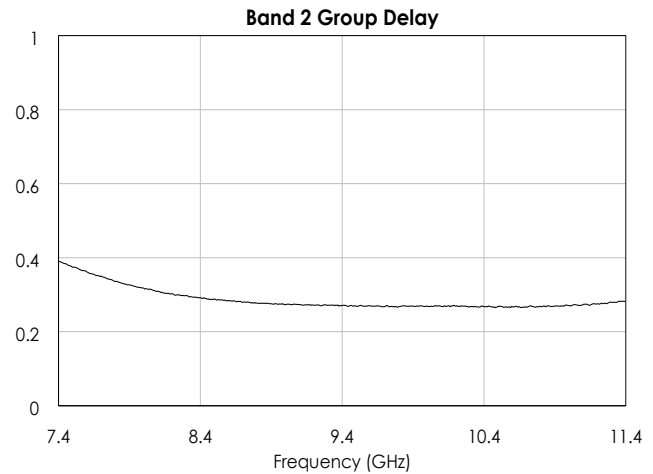
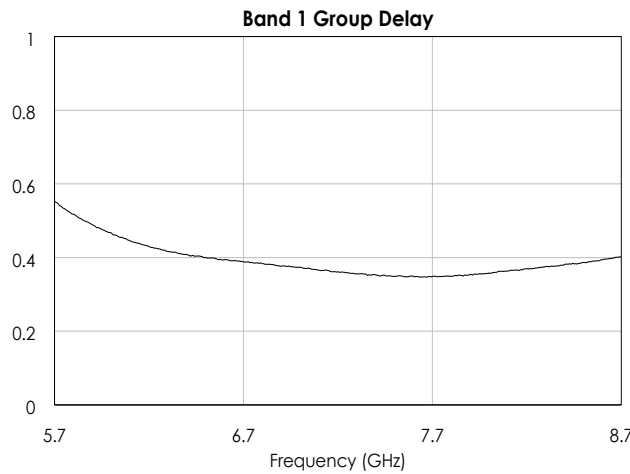
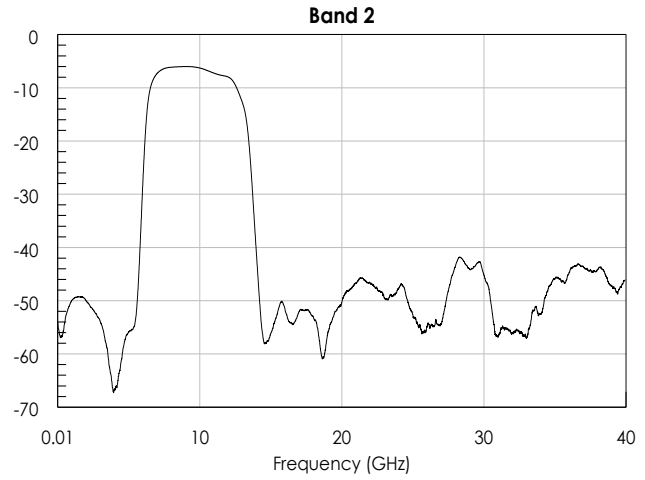
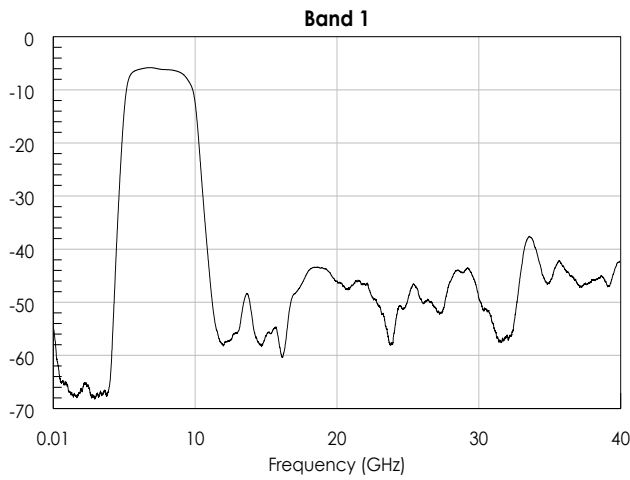

AM3186 – Filter Bank

6 to 26.5 GHz Bandpass Filter Bank

Typical Performance (continued)

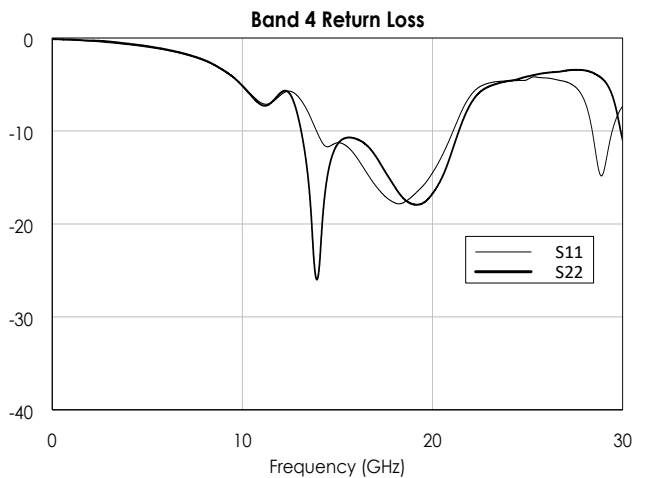
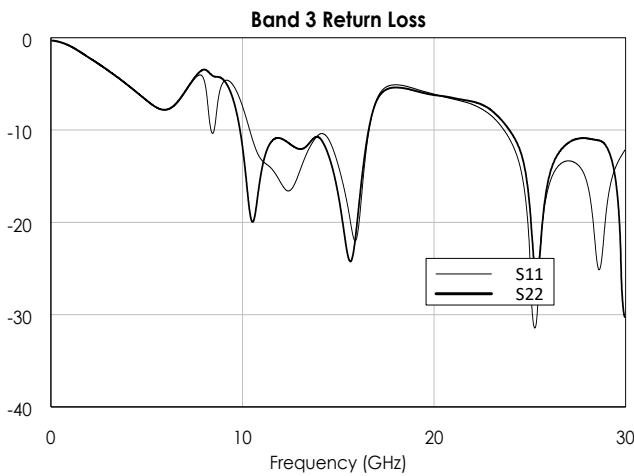
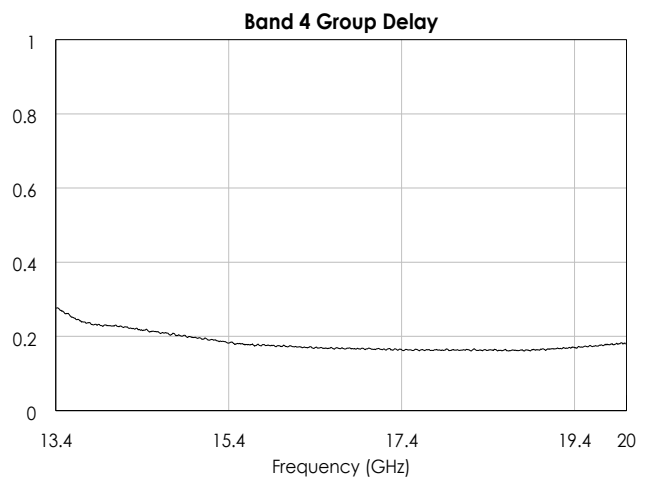
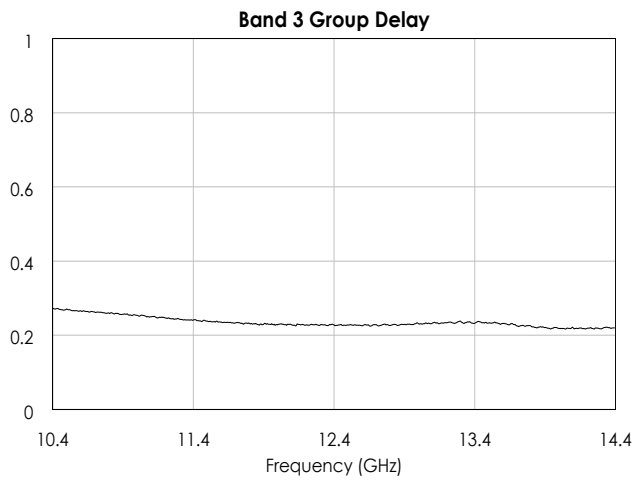
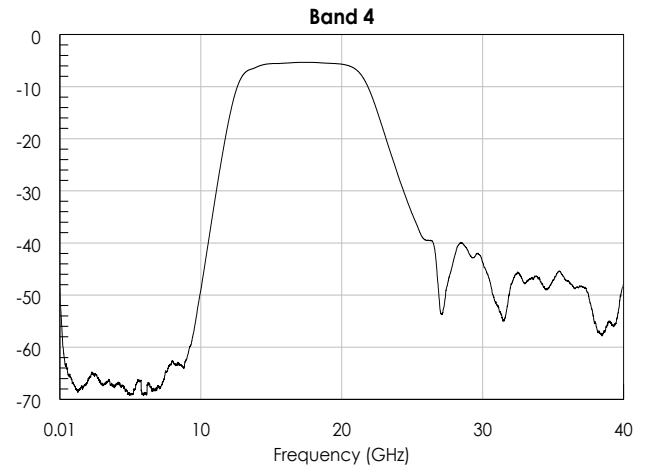
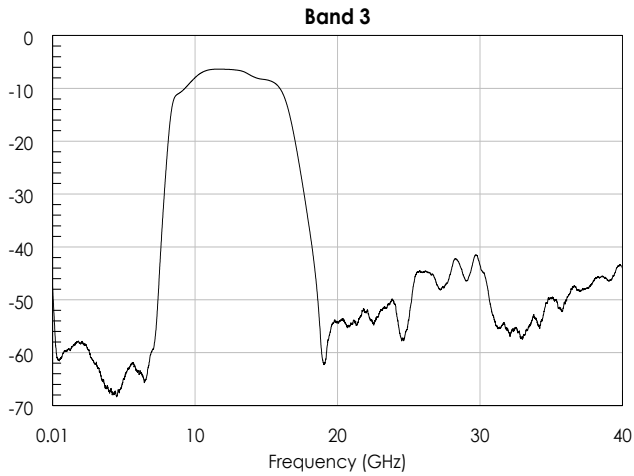

AM3186 – Filter Bank

6 to 26.5 GHz Bandpass Filter Bank

Typical Performance (continued)

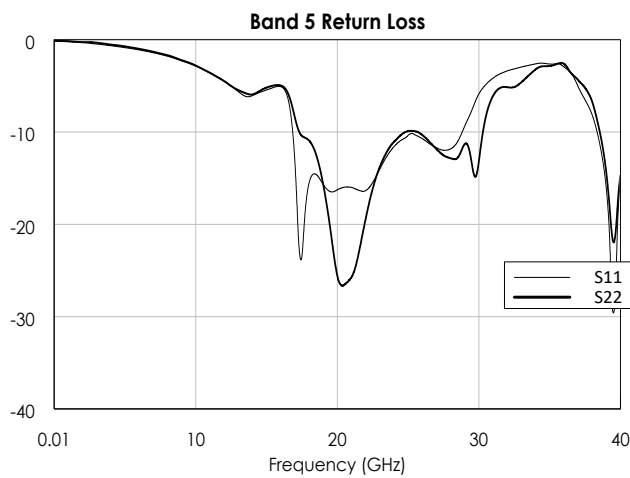
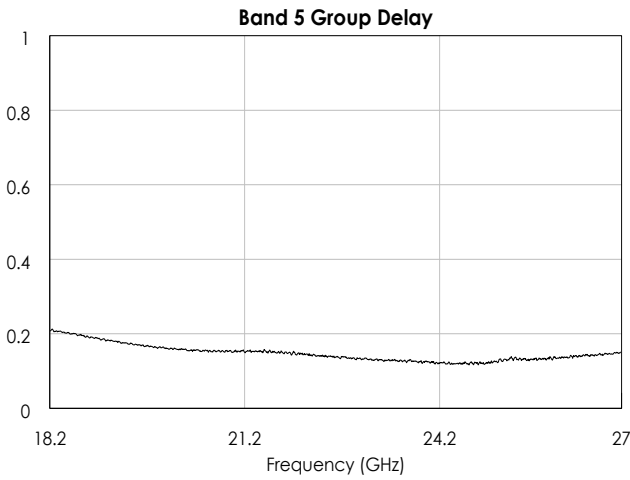
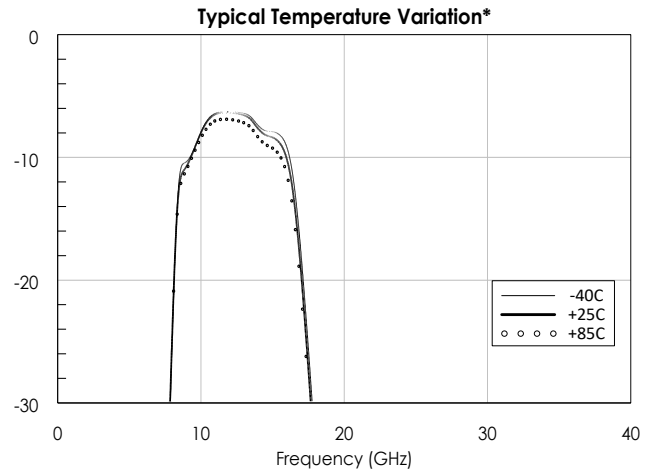
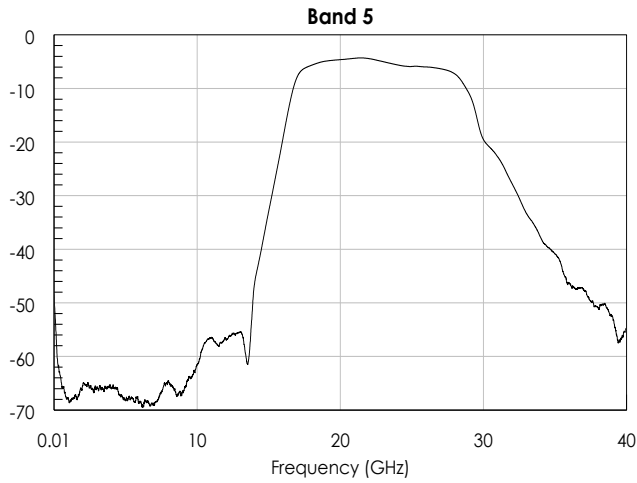

To obtain price, delivery, or to place an order contact sales@atlantamicro.com
 Atlanta Micro Inc., 3720 Davinci Ct, Suite 125, Peachtree Corners, GA 30092 • Phone: (470) 253-7640 • www.atlantamicro.com

AM3186 – Filter Bank

6 to 26.5 GHz Bandpass Filter Bank

Typical Application

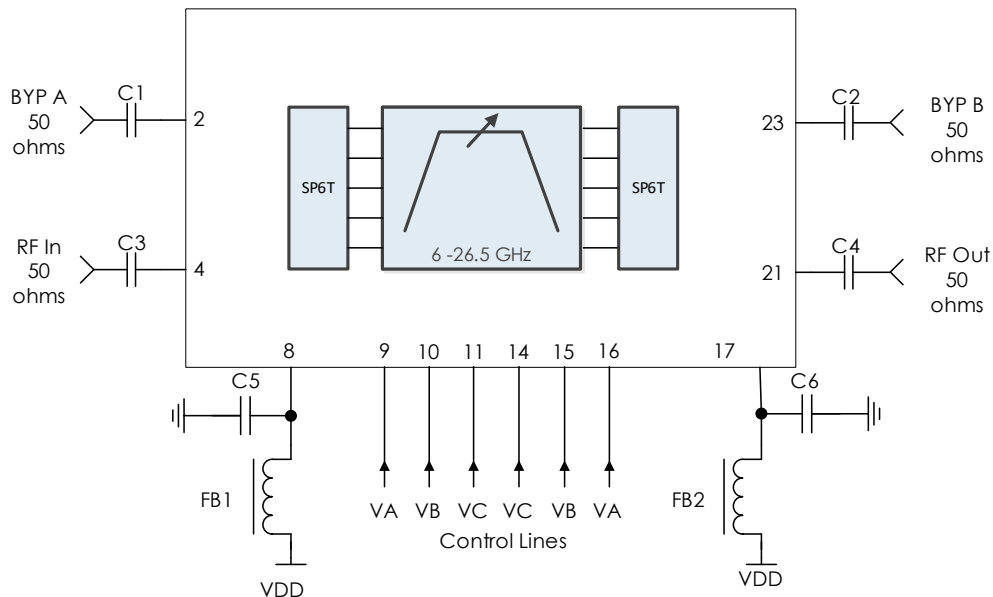

Recommended Component List (or equivalent):

Part	Value	Part Number	Manufacturer
C1-C4	0.1 μ F	0201BB104KW160	Passives Plus
FB1, FB2	Ferrite bead	MMZ1005A222E	TDK
C5, C6	0.1 μ F	C1005X7R1H104K050BB	TDK

Notes:

1. Control lines filtered internally providing high frequency isolation.
2. DC blocking capacitors should be low-loss, broadband capacitors for optimum performance.
3. Pins 9 and 16 can be directly connected on board.
4. Pins 10 and 15 can be directly connected on board.
5. Pins 11 and 14 can be directly connected on board.

AM3186 – Filter Bank

6 to 26.5 GHz Bandpass Filter Bank

Evaluation PC Board

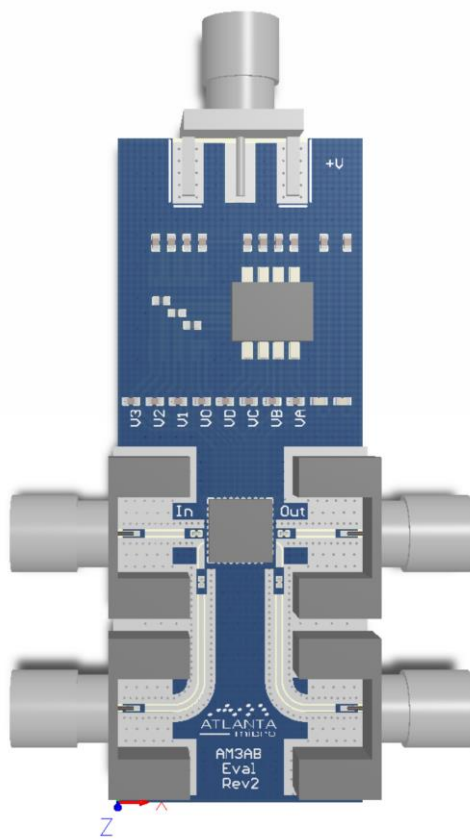

Related Parts

Part Number	Description		
AM3025A	0.4 GHz	to 6.0 GHz	Sub-Octave Bandpass Filter Bank
AM3152	0.4 GHz	to 8 GHz	Digitally Tunable Bandpass Filter
AM3153	6 GHz	to 26.5 GHz	Digitally Tunable Bandpass Filter

Component Compliance Information

RoHS: Atlanta Micro, Inc. hereby certifies that all products comply with the EC Directive 2011/65/EC on the Restriction of Hazardous Substances, commonly known as EU-RoHS 6 and 10. All products supplied by Atlanta Micro shall be compliant with the European Directive 2011/65/EC based on the following substance list.

Substance List	Allowable Maximum Concentration
Lead (Pb)	<1000 PPM (0.1% by weight)
Mercury (Hg)	<1000 PPM (0.1% by weight)
Cadmium (Cd)	<75 PPM (0.0075% by weight)
Hexavalent Chromium (CrVI)	<1000 PPM (0.1% by weight)
Polybrominated Biphenyls (PBB)	<1000 PPM (0.1% by weight)
Polybrominated Diphenyl ethers (PBDE)	<1000 PPM (0.1% by weight)
Decabromodiphenyl Deca BDE	<1000 PPM (0.1% by weight)
Bis (2-ethylhexyl) Phthalate (DEHP)	<1000 PPM (0.1% by weight)
Butyl Benzyl Phthalate (BBP)	<1000 PPM (0.1% by weight)
Dibutyl Phthalate (DBP)	<1000 PPM (0.1% by weight)
Diisobutyl Phthalate (DIBP)	<1000 PPM (0.1% by weight)

REACH: Atlanta Micro, Inc. neither uses nor intentionally adds any of the substances considered to be a Substance of Very High Concern (SVHC) as defined by the EU Regulation (EC) No. 1907-2006 on Registration, Evaluation, Authorization, and Restriction of Chemicals (REACH).

Conflict Materials: Atlanta Micro does not knowingly use materials that are sourced from the Democratic Republic of Congo (DRC) or any other known conflict regions. Atlanta Micro's supply chain is comprised of sources that are both environmentally and socially responsible. We periodically review this requirement with our vendors to ensure continued compliance.

Atlanta Micro takes its responsibility as a global partner seriously and will use due diligence within our supply chain to ensure all standards are met to the best of our knowledge.