

AM3023B – Filter Bank

Miniature Transmit / Receive with Sub-Octave Filtering

Description

AM3023B is a miniature filter bank with 10 sub-octave filters covering the 100 MHz to 6000 MHz frequency range with full 80-MHz overlap from 400 to 6000 MHz available in a 20.5mm surface mount device or a USB controlled RF-shielded module. The device contains a bypassable amplifier section and supports both transmit and receive applications. AM3023B is an excellent front-end / back-end for a broadband receiver, transmitter, or transceiver requiring high dynamic range and small size, weight, and power consumption (low SWaP).



Features

- Sub-Octave Filter Bank
- 5 dB Gain
- +3.3V Supply
- +3V Control
- 0.20 Watts Power Consumption
- 20.5mm L x 20.5mm W x 3.3mm H (0.807" L x 0.807" W x 0.13" H)
- 0.2 oz Weight
- -40C to +85C Operation
- Available in RF Shielded Module

Functional Diagram

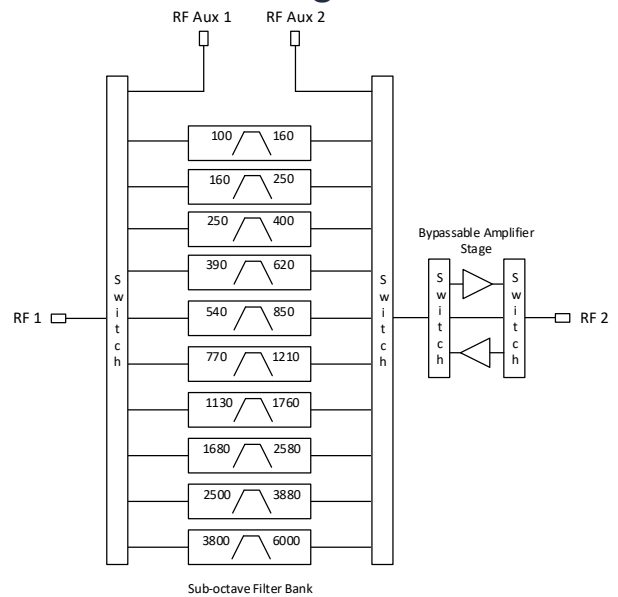

Characteristic Performance

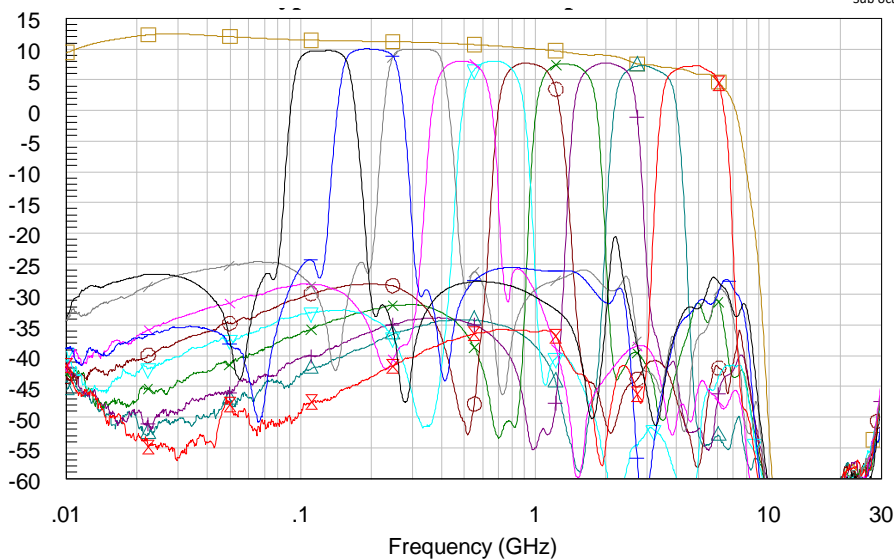

Table of Contents

Description	1	RF Performance	6
Features	1	Timing Characteristics	6
Functional Diagram	1	State Table	7
Characteristic Performance	1	Typical Performance	8
Revision History	2	Typical Application	13
Pin Layout and Definitions	3	Part Ordering Details	15
Specifications	4	Related Parts	15
Absolute Maximum Ratings.....	5	9mm 24 Lead QFN Details	16
Handling Information.....	5	Evaluation PC Board Details	18
Recommended Operating Conditions....	5	RF Shielded Module Details	19
DC Electrical Characteristics	6	Component Compliance Information	20

Revision History

Date	Revision Number	Notes
February 2, 2017	A4	Part picture updated. Added performance plot to first page.
September 12, 2019	5	Updated to new datasheet format. More comprehensive part data included.

AM3023B – Filter Bank

Miniature Transmit / Receive with Sub-Octave Filtering

Pin Layout and Definitions

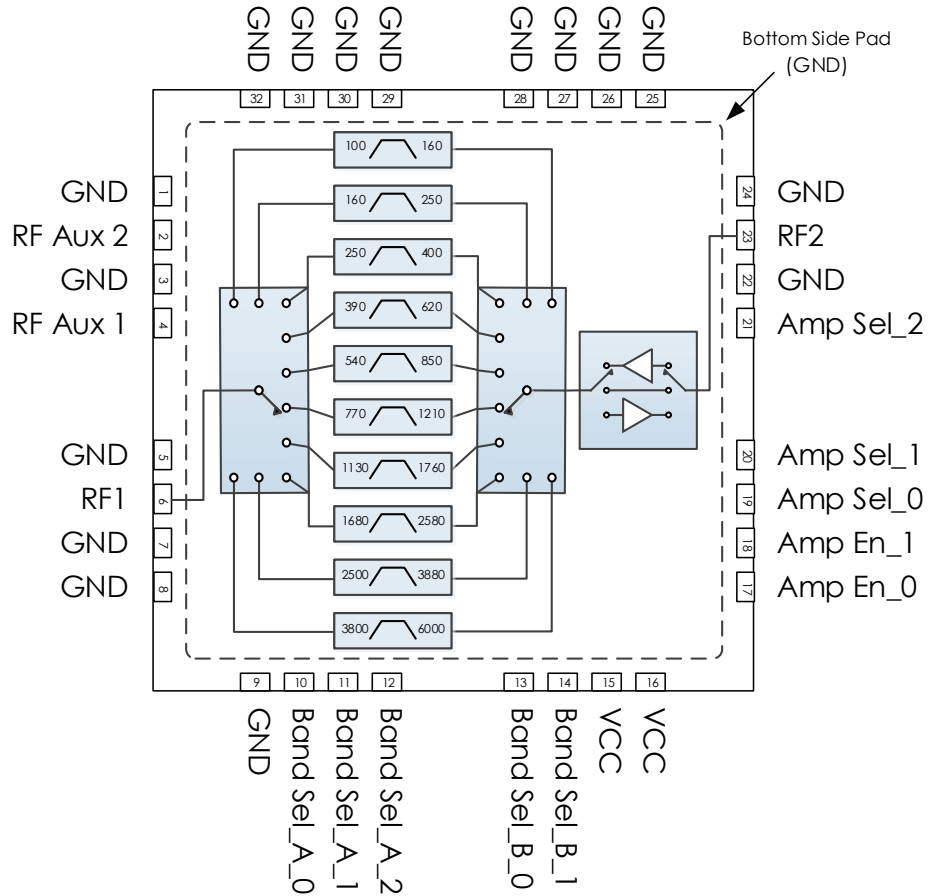

Pin Number	Pin Name	Pin Function
1	GND	Ground - Common
2	RF Aux 2	Optional 2 MHz to 6 GHz RF port – Pin 4 Return * - 50 Ohms – AC Coupled
3	GND	Ground - Common
4	RF Aux 1	Optional 2 MHz to 6 GHz RF port – Pin 2 Return * - 50 Ohms – AC Coupled
5	GND	Ground – Common
6	RF 1	RF Port 1 – 50 Ohms – AC Coupled
7-9	GND	Ground – Common
10	Band Sel_A_0	Filter Band Select A_0
11	Band Sel_A_1	Filter Band Select A_1
12	Band Sel_A_2	Filter Band Select A_2
13	Band Sel_B_0	Filter Band Select B_0
14	Band Sel_B_1	Filter Band Select B_1
15	VCC	DC Power Input

***Note:** Can be used for external filtering or connected to return pin for a filter bypass path.

AM3023B – Filter Bank

Miniature Transmit / Receive with Sub-Octave Filtering

Pin Layout and Definitions (continued)

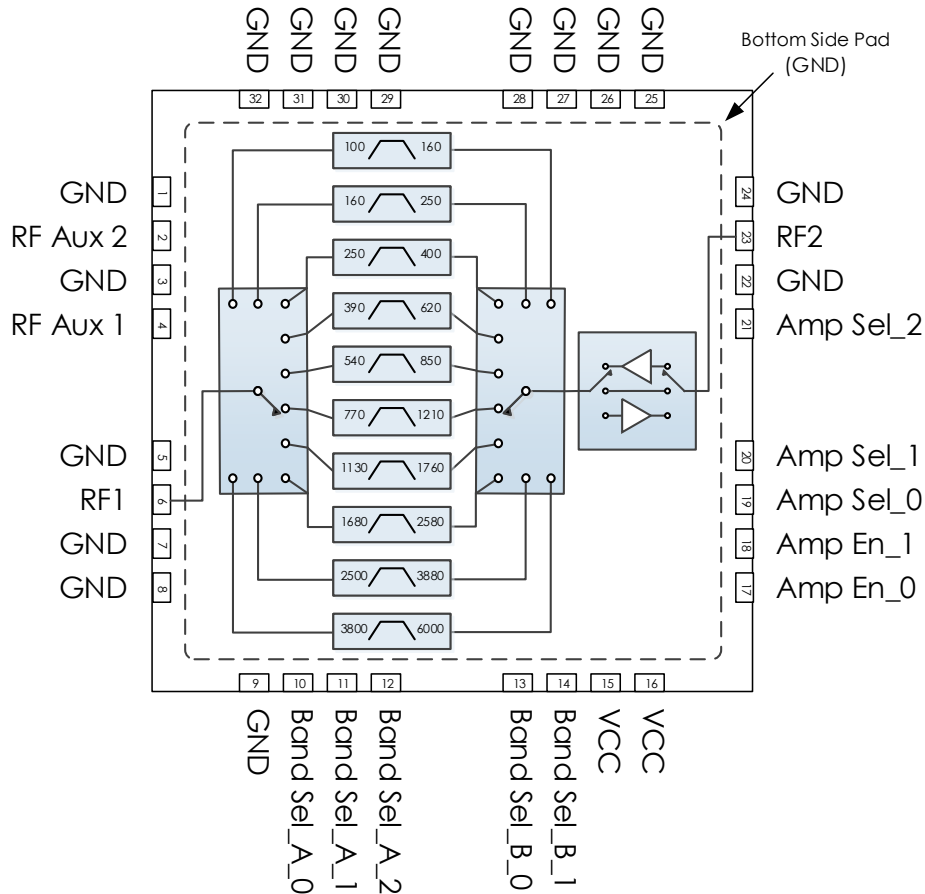

Pin Number	Pin Name	Pin Function
16	VCC	DC Power Input
17	Amp En_0	Amplifier Enable Bit 0
18	Amp En_1	Amplifier Enable Bit 1
19	Amp Sel_0	Amplifier Select Bit 0
20	Amp Sel_1	Amplifier Select Bit 1
21	Amp Sel_2	Amplifier Select Bit 2
22	GND	Ground – Common
23	RF 2	RF Port 2 – 50 Ohms – AC Coupled
24-32	GND	Ground – Common
Bottom Pad	GND	Ground – Common

AM3023B – Filter Bank

Miniature Transmit / Receive with Sub-Octave Filtering

Specifications

Absolute Maximum Ratings

	Minimum	Maximum
Supply Voltage	-0.3 V	+3.7 V
RF Input Power		+17 dBm
Operating Junction Temperature	-40 C	+150 C
Storage Temperature Range	-50 C	+150 C

Note: Any device operation beyond the Absolute Maximum Ratings may result in permanent damage to the device. The values listed in this table are extremes and do not imply functional operation of the device at these or any other conditions beyond what is listed under Recommended Operating Conditions. Any part subjected to conditions outside of what is recommended for an extended amount of time may suffer from reliability concerns.

Handling Information

	Minimum	Maximum
Storage Temperature Range (Recommended)	-50 C	+125 C
Moisture Sensitivity Level	MSL 3	



Atlanta Micro products are electrostatic sensitive.
Follow safe handling practices to avoid damage

Recommended Operating Conditions

	Minimum	Typical	Maximum
Supply Voltage	+3.1 V	+3.3 V	+3.5 V
Operating Case Temperature	-40 C		+85 C
Operating Junction Temperature	-40 C		+125 C

AM3023B – Filter Bank

Miniature Transmit / Receive with Sub-Octave Filtering

DC Electrical Characteristics

(T = 25 °C unless otherwise specified)

Parameter	Testing Conditions	Minimum	Typical	Maximum
DC Supply Voltage		+3.1 V	+3.3 V	+3.5 V
DC Supply Current	V _{CC} = +3.3 V		60 mA	
Control Line Current			<1 mA	
Power Dissipated	V _{CC} = +3.3 V		0.20 W	
Logic Level Low		-0.1 V		+0.4 V
Logic Level High		+2.7 V		+3.3 V

RF Performance

(T = 25 °C unless otherwise specified)

Parameter	Testing Conditions	Minimum	Typical	Maximum
Frequency Range	Auxiliary Port	2 MHz		6 GHz
	Sub-octave Filtering	100 MHz		6 GHz
Gain	RF1 to RF2, Amplifier En		7 dB	
	RF1 to RF2, Amplifier Byp		-6 dB	
	RF2 to RF1, Amplifier En		7 dB	
	RF2 to RF1, Amplifier Byp		-10 dB	
Input IP3	RF1 to RF2, Amplifier En		+22 dBm	
	RF1 to RF2, Amplifier Byp		+40 dBm	
Input IP2	RF1 to RF2, Amplifier En		+60 dBm	
	RF1 to RF2, Amplifier Byp		+70 dBm	
Noise Figure	RF1 to RF2, Amplifier En		9 dB	
	RF1 to RF2, Amplifier Byp		6 dB	
	RF2 to RF1, Amplifier En		4 dB	
	RF2 to RF1, Amplifier Byp		6 dB	
Output IP3	RF2 to RF1, Amplifier En		+23 dBm	
	RF2 to RF1, Amplifier Byp		+32 dBm	
Output P1dB	RF2 to RF1, Amplifier En		+10 dBm	
	RF2 to RF1, Amplifier Byp		+16 dBm	
Input Return Loss			10 dB	
Output Return Loss			10 dB	

Timing Characteristics

Parameter	Minimum	Typical	Maximum
Filter / Amplifier Switching Speed			1 μs
Amplifier Enabled Speed			2.5 ms

Note: Switching speed measured without any control line filters. Switching speed measured as time from 50% control to 50% RF.

AM3023B – Filter Bank

Miniature Transmit / Receive with Sub-Octave Filtering

State Tables

A_0	A_1	A_2	B_0	B_1	Filter Band
Low	Low	Low	High	High	RF Aux 1 / RF Aux 2
Low	Low	Low	Low	Low	100 – 160 MHz
Low	Low	Low	Low	High	160 – 250 MHz
Low	Low	Low	High	Low	250 – 400 MHz
Low	Low	High	Low	Low	390 – 620 MHz
High	High	High	Low	Low	540 – 850 MHz
High	High	Low	Low	Low	770 – 1210 MHz
Low	High	Low	Low	Low	1130 – 1760 MHz
High	Low	High	Low	Low	1680 – 2580 MHz
High	Low	Low	Low	Low	2500 – 3880 MHz
Low	High	High	Low	Low	3800 – 6000 MHz

***Note:** Filter band control table is not the same as AM3023 / AM3023A

Amp Sel_0	Amp Sel_1	Amp Sel_2	Amplifier Path
Low	Low	High	RF1 to RF2
Low	High	Low	Amplifier Bypass
High	Low	Low	RF2 to RF1

Amp En_0	Amp En_1	Amplifier Enable Status
Low	Low	Both Amps Off
Low	High	RF2 to RF1 Amp Enabled
High	Low	RF1 to RF2 Amp Enabled
High	High	Both Amps Enabled

***Note:** Amplifier enable switching speed is 2.5ms max. If a 2.5ms overall switching speed is acceptable, the number of control lines can be reduced and Amp Sel_0 can be connected to Amp En_1 and Amp Sel_2 can be connected to Amp En_0.

AM3023B – Filter Bank

Miniature Transmit / Receive with Sub-Octave Filtering

Typical Performance

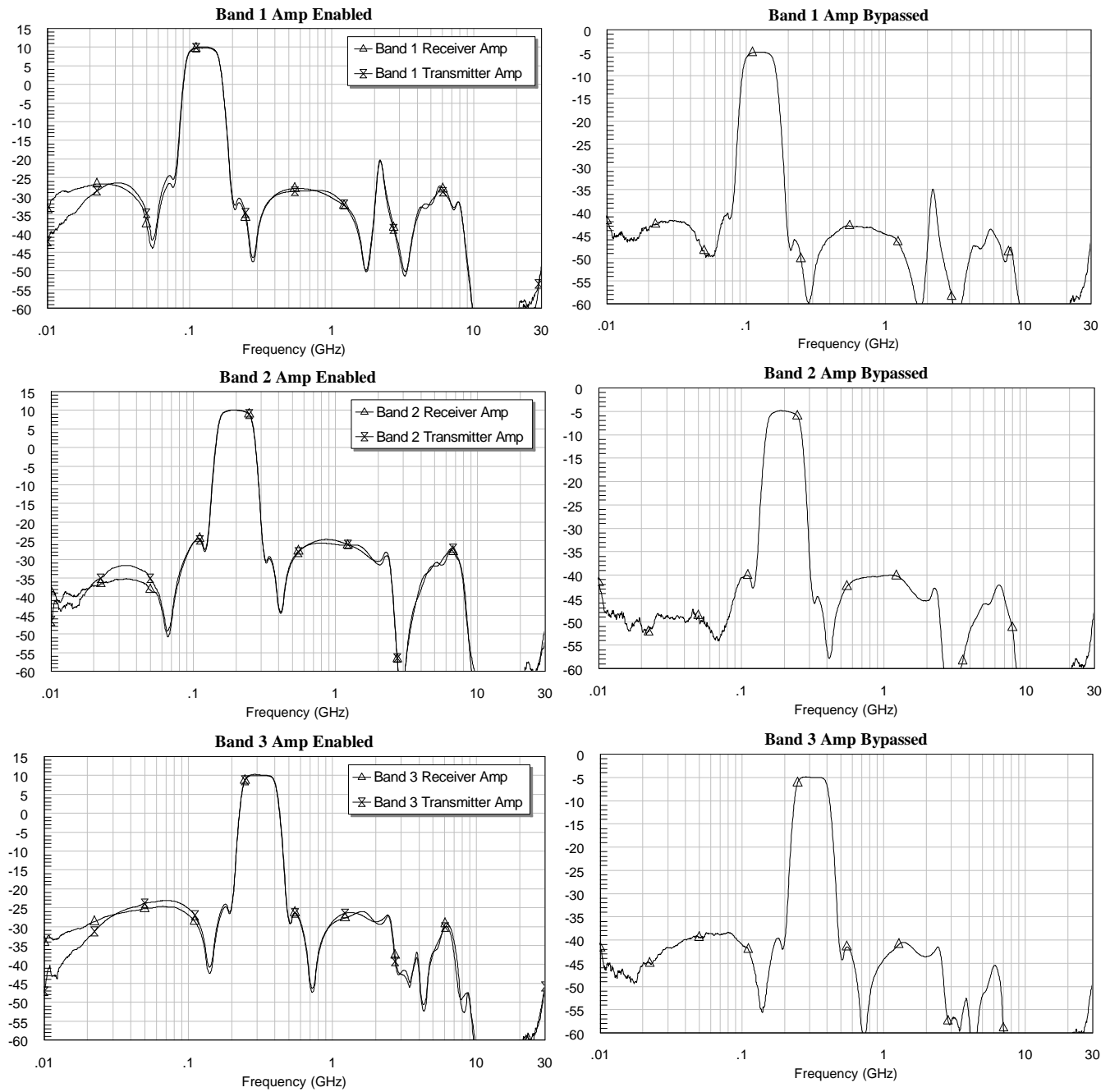

To obtain price, delivery, or to place an order contact sales@atlantamicro.com
 Atlanta Micro Inc., 3720 Davinci Ct, Suite 125, Norcross, GA 30092 • Phone: (470) 253-7640 • www.atlantamicro.com

AM3023B – Filter Bank

Miniature Transmit / Receive with Sub-Octave Filtering

Typical Performance (continued)

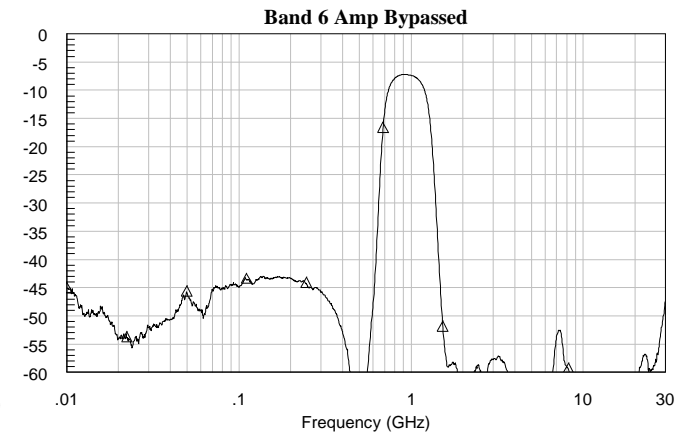
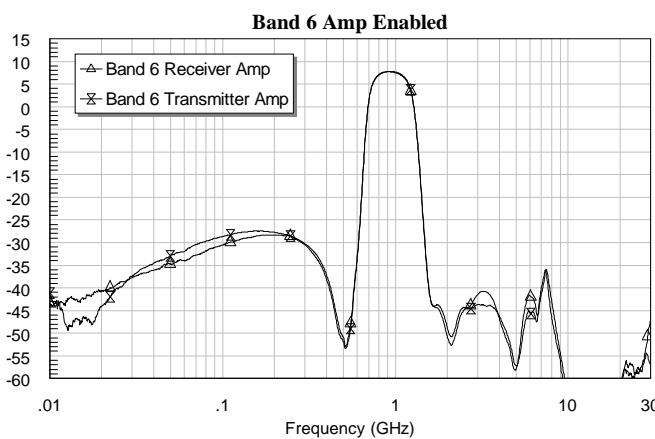
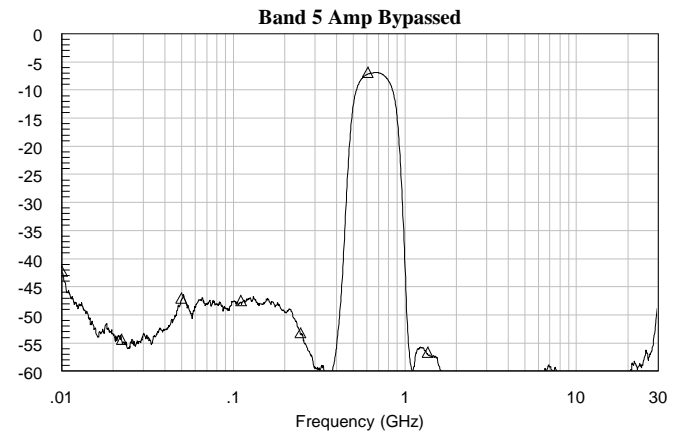
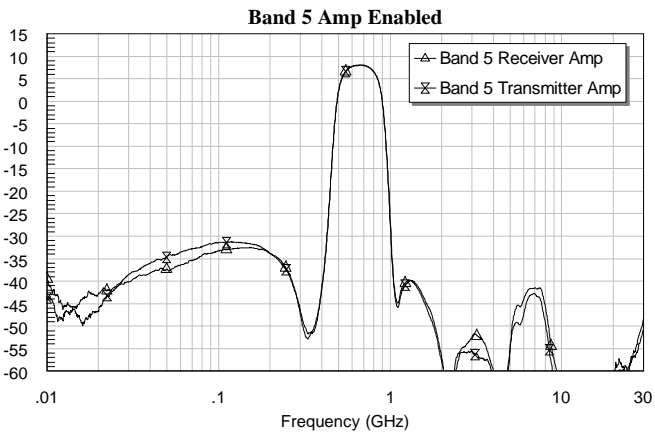
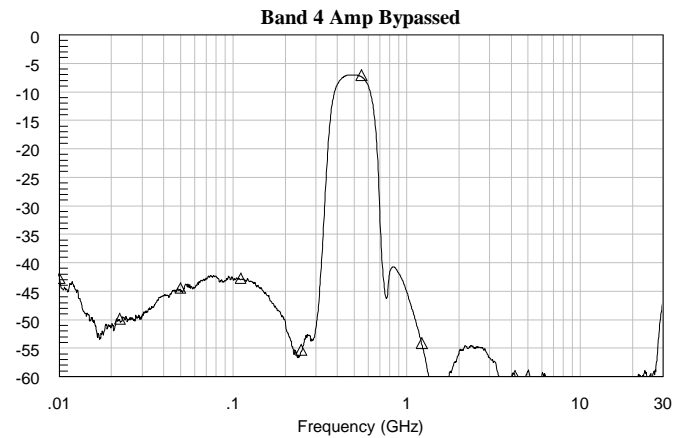
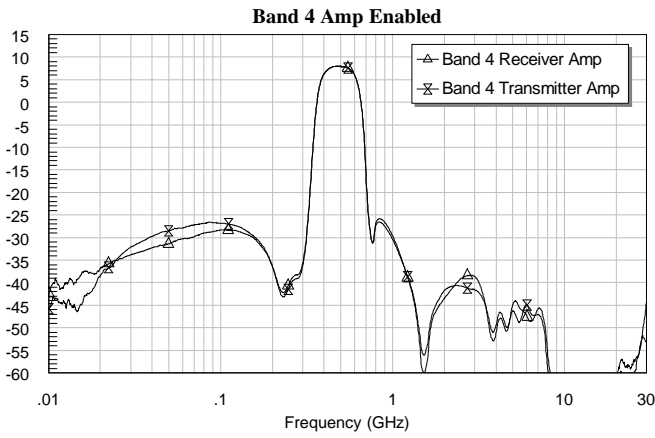

AM3023B – Filter Bank

Miniature Transmit / Receive with Sub-Octave Filtering

Typical Performance (continued)

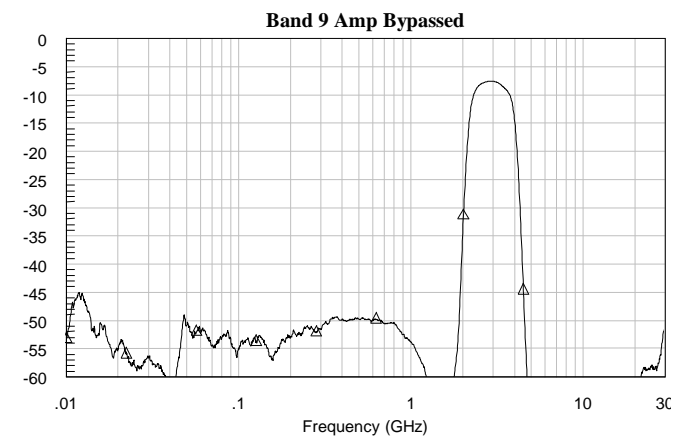
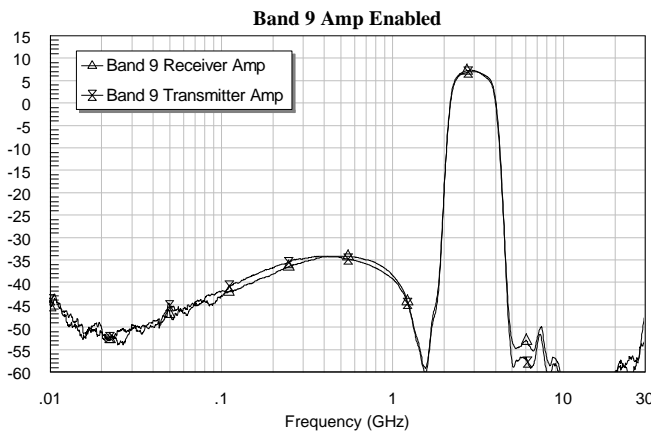
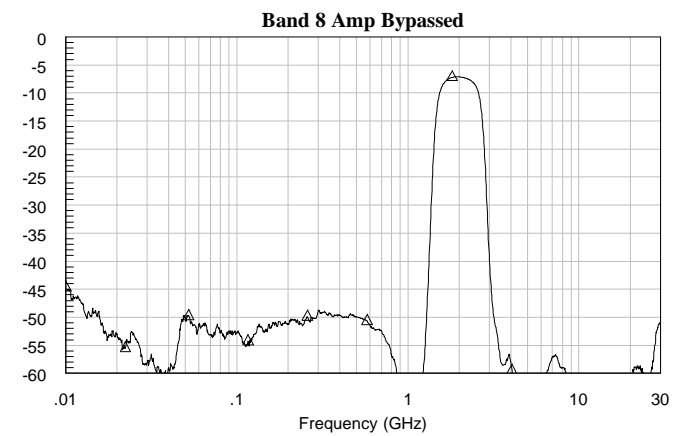
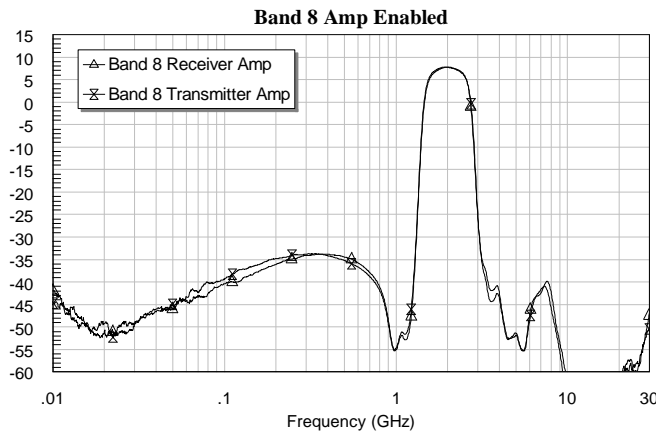
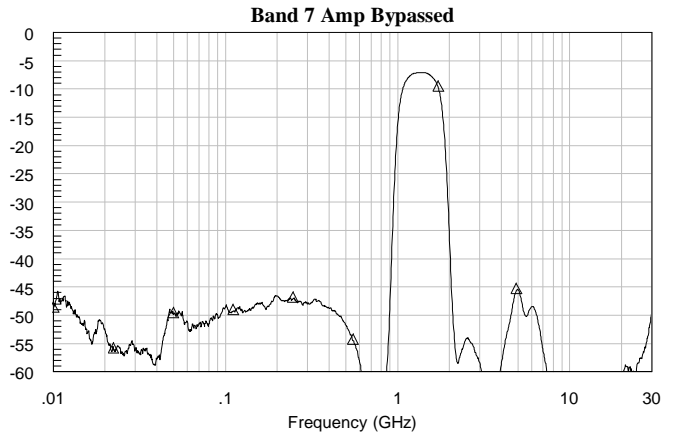
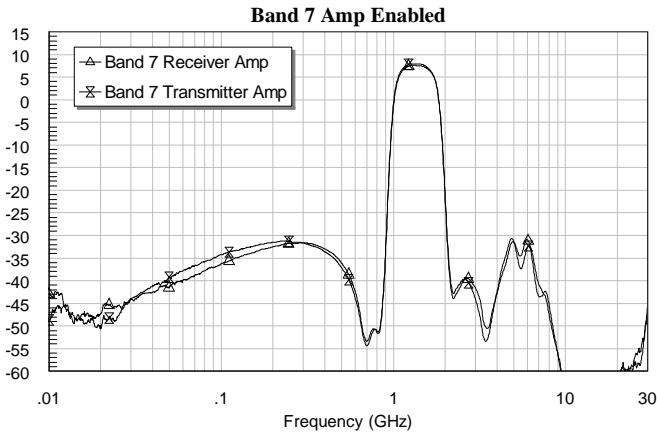

AM3023B – Filter Bank

Miniature Transmit / Receive with Sub-Octave Filtering

Typical Performance (continued)

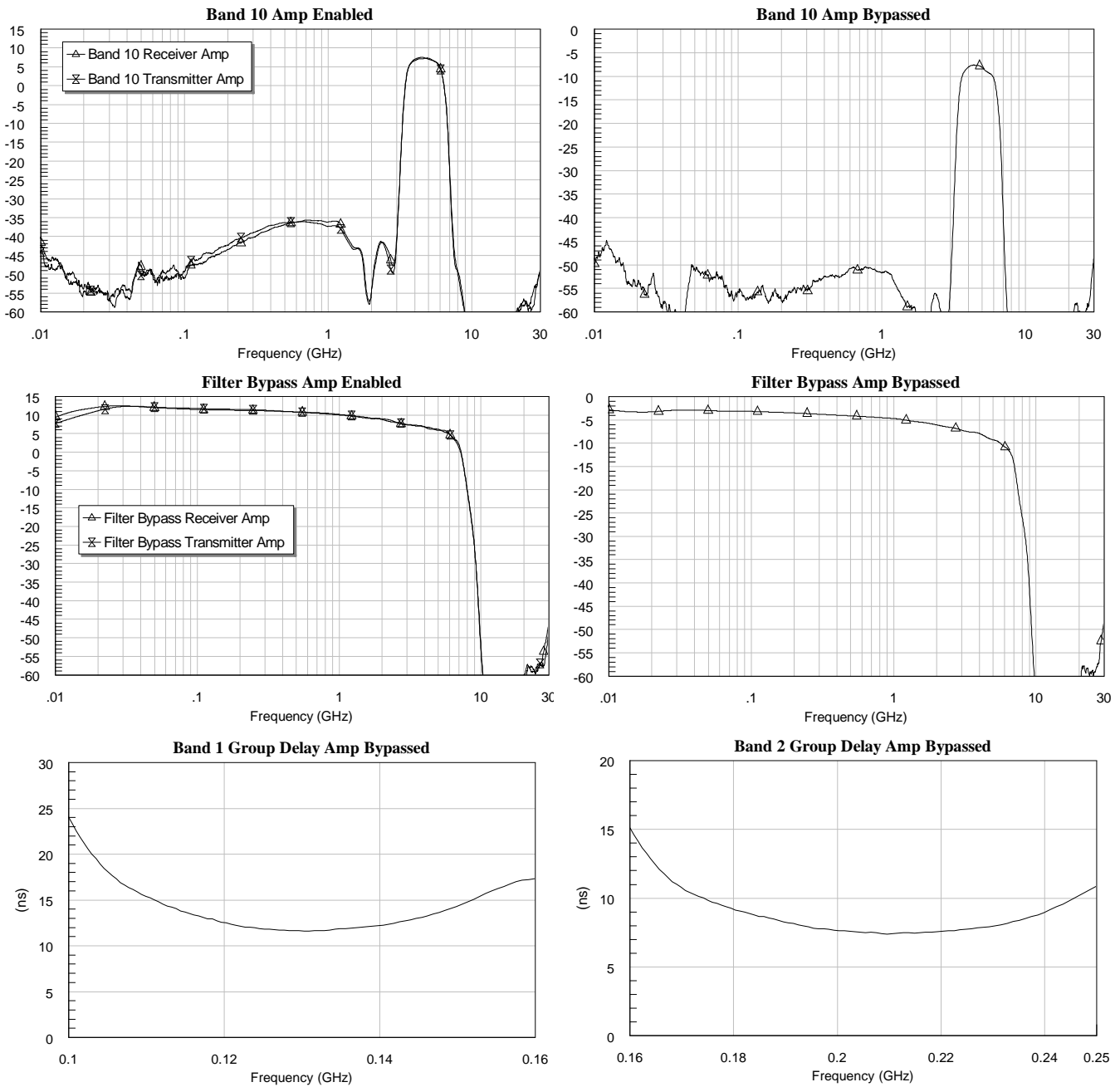

***Note:** Filter Bypass data shows auxiliary path with 50 ohm trace connecting the two ports.

AM3023B – Filter Bank

Miniature Transmit / Receive with Sub-Octave Filtering

Typical Performance (continued)

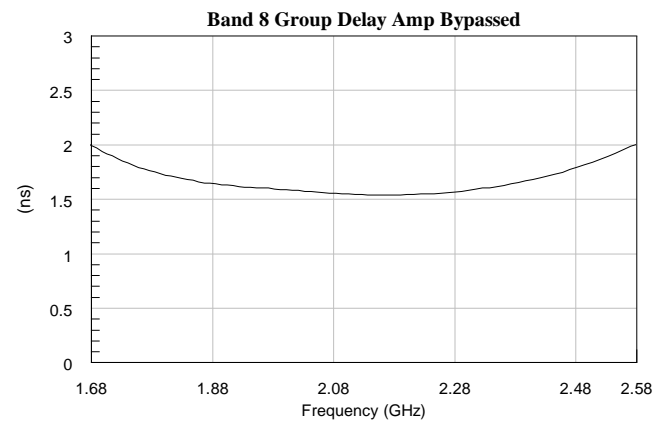
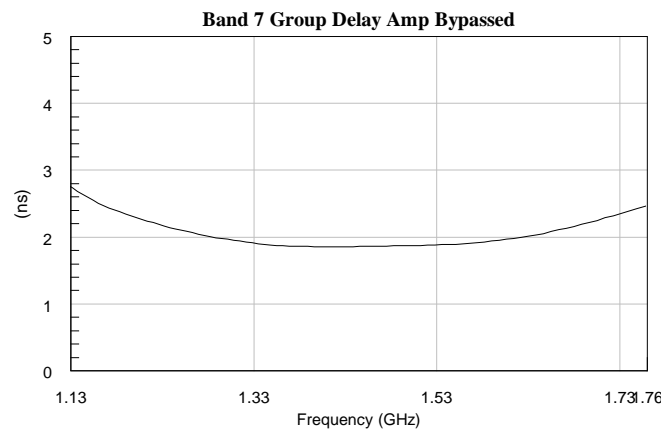
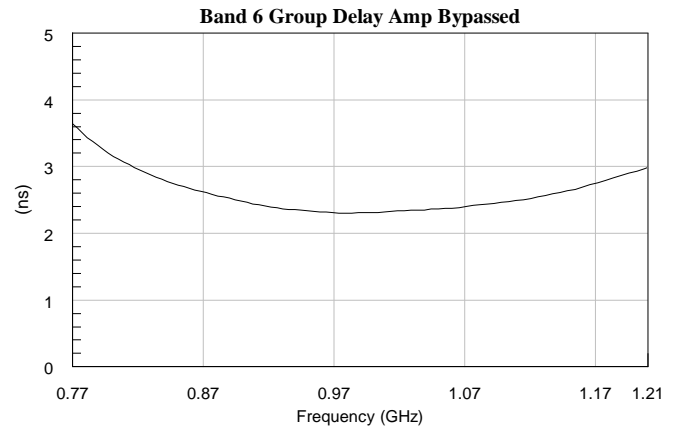
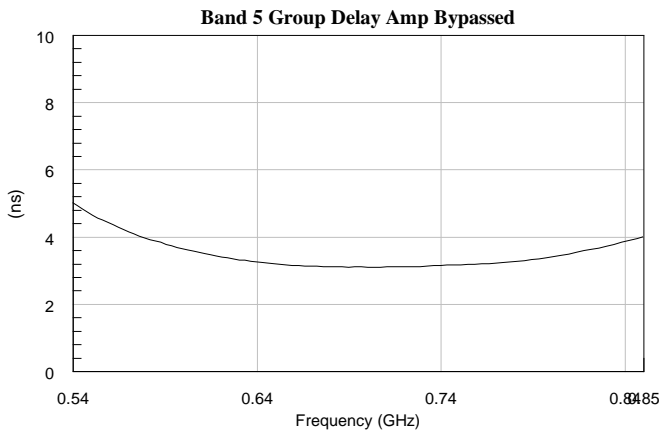
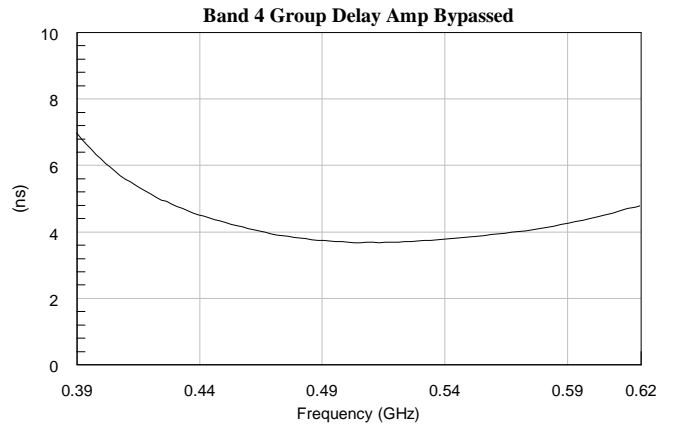
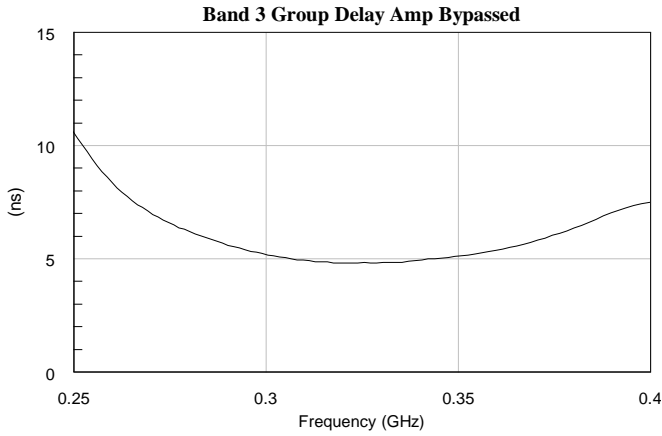

AM3023B – Filter Bank

Miniature Transmit / Receive with Sub-Octave Filtering

Typical Performance (continued)

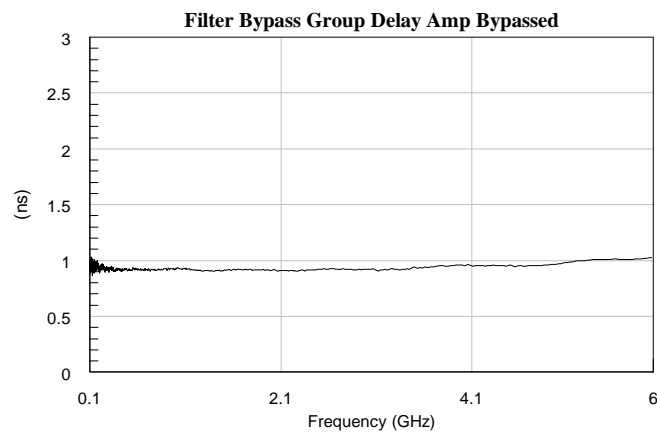
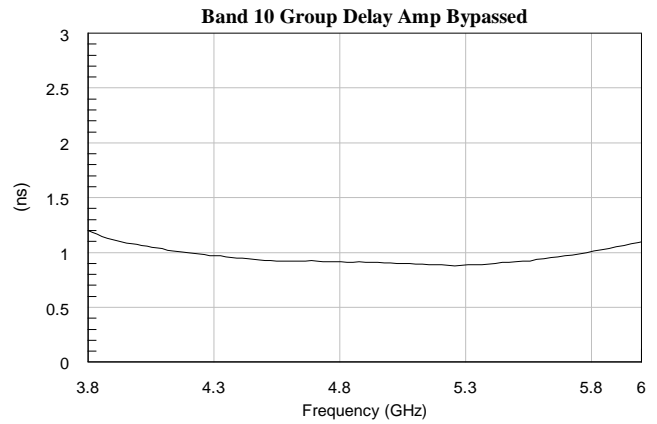
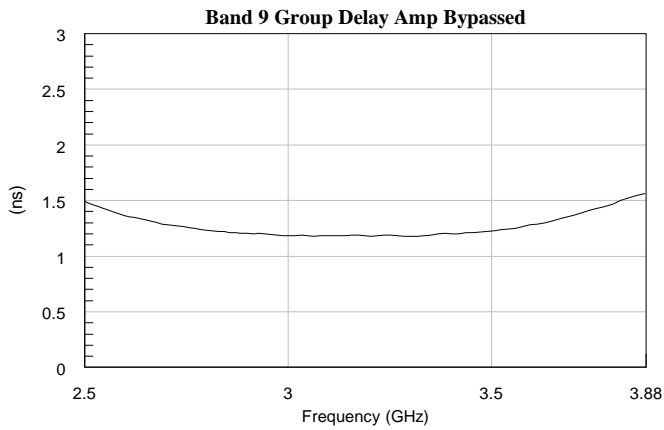

AM3023B – Filter Bank

Miniature Transmit / Receive with Sub-Octave Filtering



Typical Application

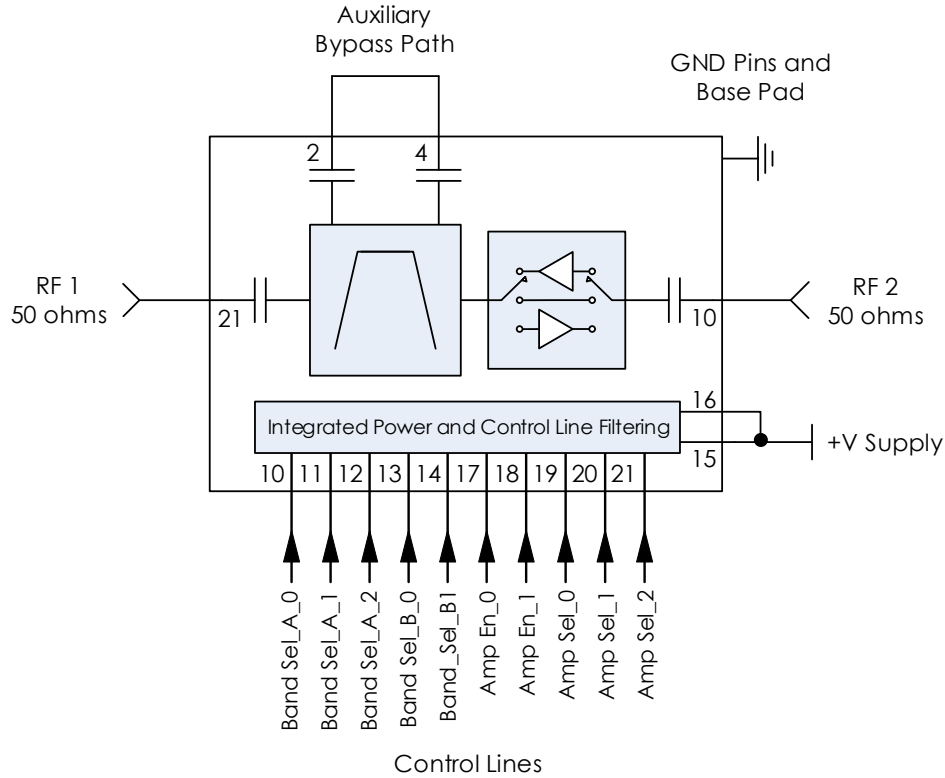

Notes:

1. RF Aux 1 and RF Aux 2 are optional ports that can be used for external filtering or can be connected together to provide a filter bypass path.
2. Internal RC filtering time constant is 220 ns.

AM3023B – Filter Bank



Miniature Transmit / Receive with Sub-Octave Filtering

Part Ordering Details

Description	Part Number
20.5mm 32 Lead PCB as Surface Mount Package	AM3023B
AM3023B IC on PCB with Thru Cal and USB Control with SMA or Header Pin Voltage Input	AM3023B Eval
AM3023B in 2.10"x2.10"x0.65" RF-Shielded Module with USB Control, Power via USB or External Pin with Integrated Linear Regulator, and Field Replaceable SMA Connectors.	AM3023B-M

NOTE: AM3023B-M is NOT bi-directional. Device currently only supports uni-directional bypassable amplifier.

Related Parts

Part Number	Description
AM3024B	100 MHz to 6 GHz Switched Sub-Octave Filter Bank w/ Bypassable Amplifier
AM3025A	400 MHz to 6 GHz Switched Sub-Octave Filter Bank
AM3060	320 MHz to 6.5 GHz Switched Digitally Tunable Preselector Filter Bank
AM3089	2 GHz to 18 GHz Switched Analog Tunable Bandpass Filter Bank
AM3063	6 GHz to 18 GHz Digitally Tunable Bandpass Filter Bank
AM3064	1 GHz to 6.5 GHz Digitally Tunable Bandpass Filter Bank
AM3066	12 GHz to 26.5 GHz Digitally Tunable Bandpass Filter Bank

AM3023B – Filter Bank

Miniature Transmit / Receive with Sub-Octave Filtering

20.5mm 32 Lead Package Details

Package Drawing

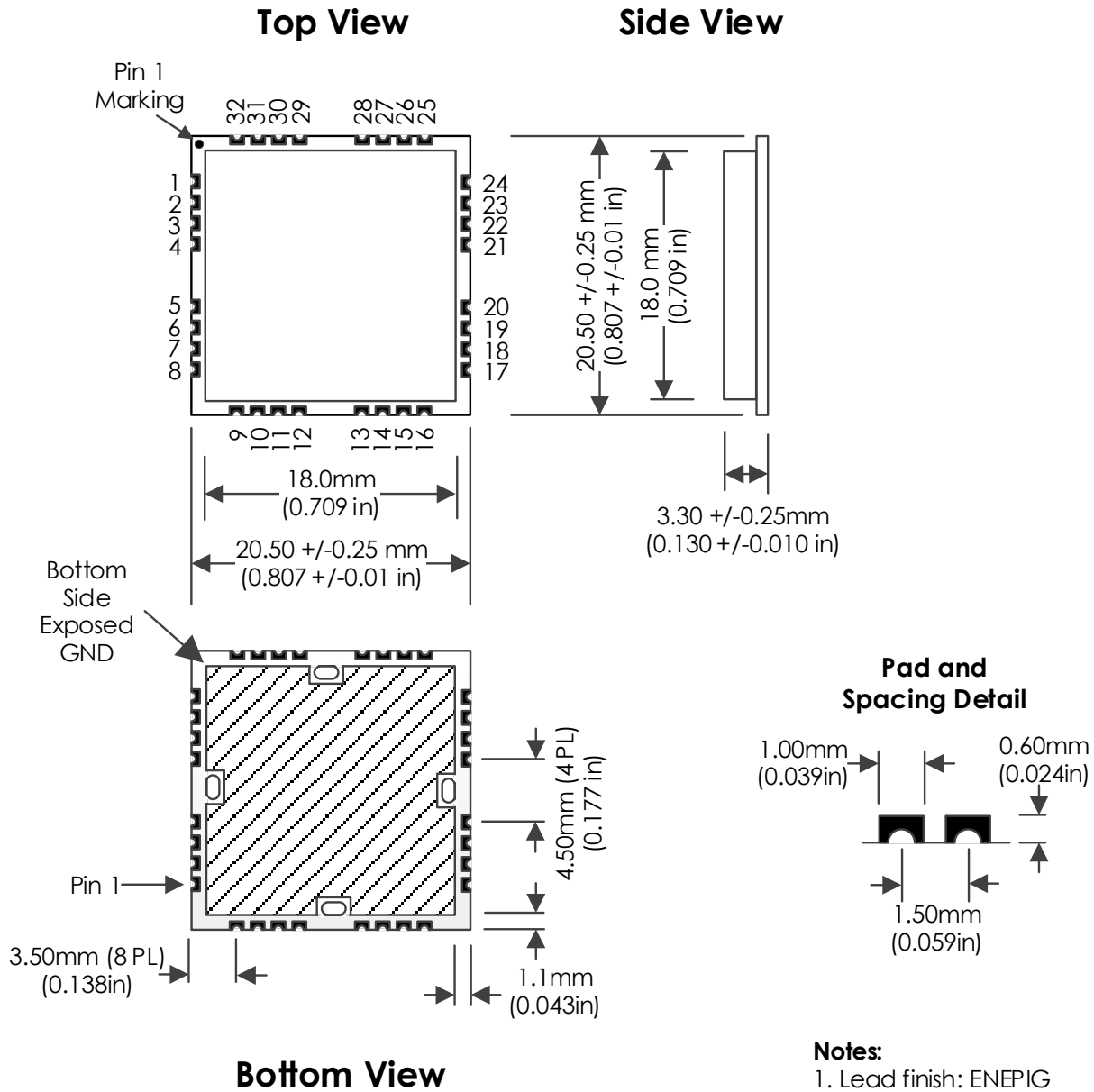

***Note:** Height change from AM3023A from 0.12" nominal to 0.13" nominal

AM3023B – Filter Bank

Miniature Transmit / Receive with Sub-Octave Filtering

20.5mm 32 Lead Package Details (continued)

Recommended Footprint

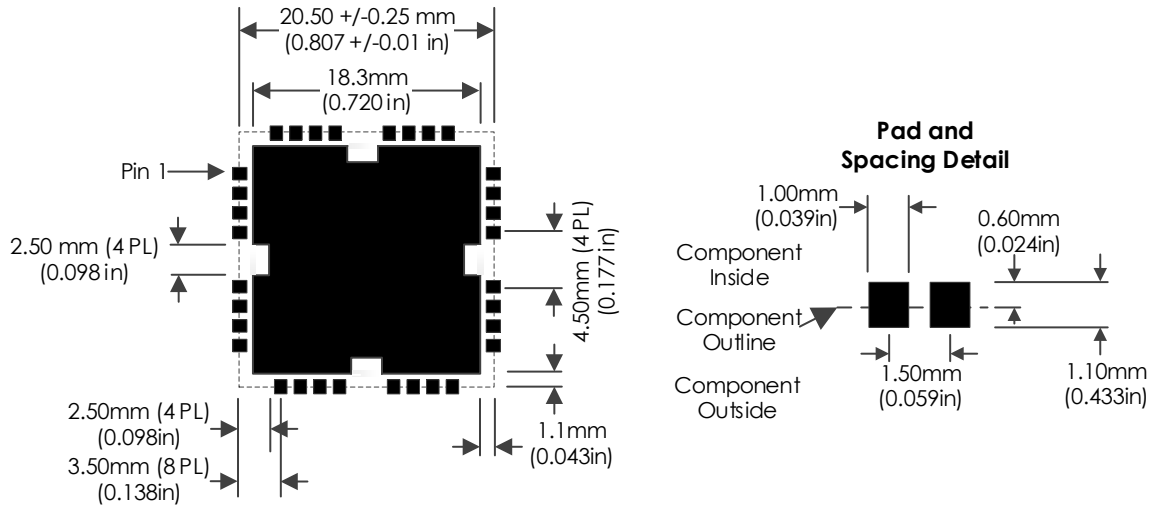

Recommended Assembly Procedure

It is recommended to attach the bottom side ground pad to the printed circuit board using a highly conductive silver epoxy and then hand solder the 32 pins along the part's perimeter to their intended printed circuit board pads using lead-free solder.

The recommended silver epoxy is MG Chemicals part 8331S and the recommended assembly thickness is 3 to 5 mils.

If the device is to be attached (both the ground pad and perimeter pins) to the circuit board using a typical lead-free solder reflow process reaching temperatures of 260C, the excessive temperature can cause internal parts to the filter bank to reflow and result in damage to the device. If a solder reflow process must be used, it is recommended to use a lower temperature leaded solder profile, typically 225C maximum.

AM3023B – Filter Bank

Miniature Transmit / Receive with Sub-Octave Filtering

Evaluation PC Board Details

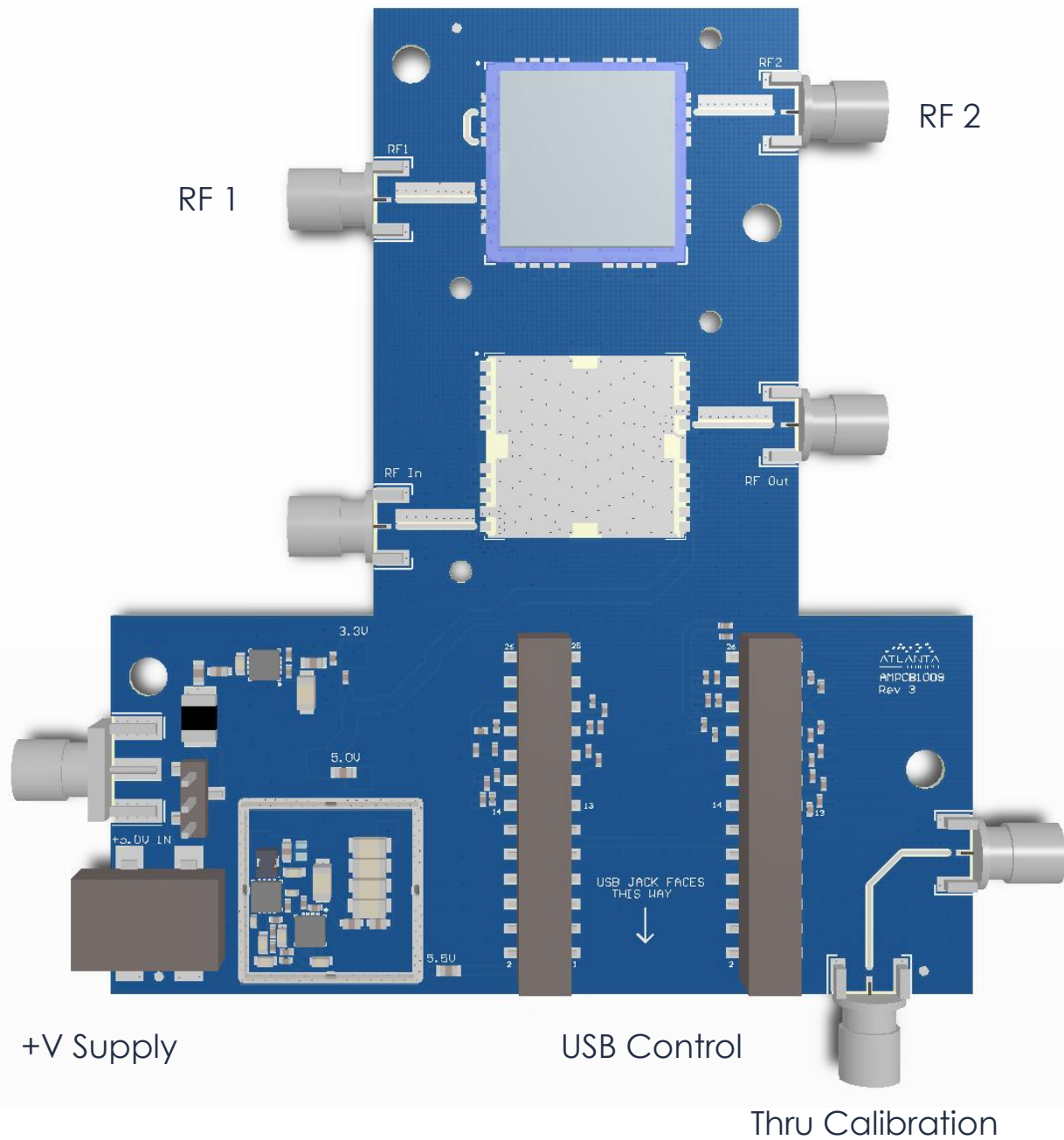

AM3023B – Filter Bank

Miniature Transmit / Receive with Sub-Octave Filtering



RF Shielded Module Details



Top View

Bottom View

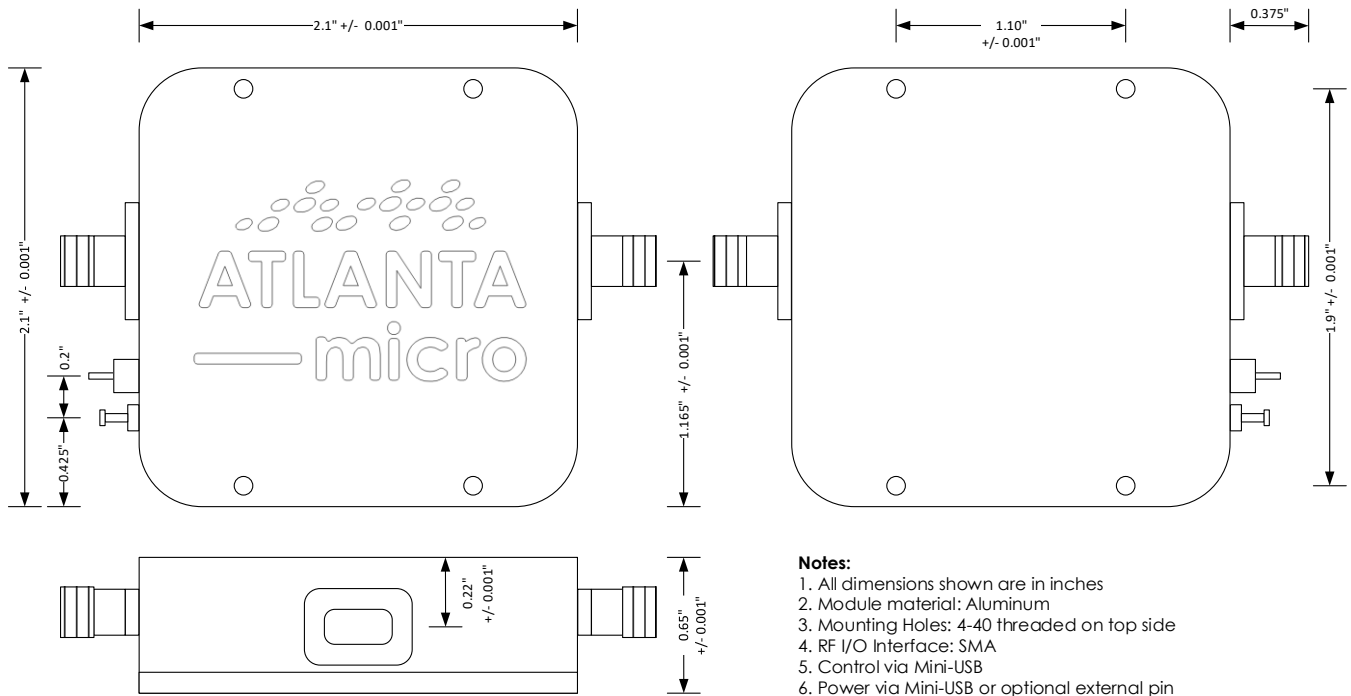

Front View

- Notes:**
1. All dimensions shown are in inches
 2. Module material: Aluminum
 3. Mounting Holes: 4-40 threaded on top side
 4. RF I/O Interface: SMA
 5. Control via Mini-USB
 6. Power via Mini-USB or optional external pin

To obtain price, delivery, or to place an order contact sales@atlantamicro.com
Atlanta Micro Inc., 3720 Davinci Ct, Suite 125, Norcross, GA 30092 • Phone: (470) 253-7640 • www.atlantamicro.com

Component Compliance Information

RoHS: Atlanta Micro, Inc. hereby certifies that all products comply with the EC Directive 2011/65/EC on the Restriction of Hazardous Substances, commonly known as EU-RoHS 6 and 10. All products supplied by Atlanta Micro shall be compliant with the European Directive 2011/65/EC based on the following substance list.

Substance List	Allowable Maximum Concentration
Lead (Pb)	<1000 PPM (0.1% by weight)
Mercury (Hg)	<1000 PPM (0.1% by weight)
Cadmium (Cd)	<75 PPM (0.0075% by weight)
Hexavalent Chromium (CrVI)	<1000 PPM (0.1% by weight)
Polybrominated Biphenyls (PBB)	<1000 PPM (0.1% by weight)
Polybrominated Diphenyl ethers (PBDE)	<1000 PPM (0.1% by weight)
Decabromodiphenyl Deca BDE	<1000 PPM (0.1% by weight)
Bis (2-ethylhexyl) Phthalate (DEHP)	<1000 PPM (0.1% by weight)
Butyl Benzyl Phthalate (BBP)	<1000 PPM (0.1% by weight)
Dibutyl Phthalate (DBP)	<1000 PPM (0.1% by weight)
Diisobutyl Phthalate (DIBP)	<1000 PPM (0.1% by weight)

REACH: Atlanta Micro, Inc. neither uses nor intentionally adds any of the substances considered to be a Substance of Very High Concern (SVHC) as defined by the EU Regulation (EC) No. 1907-2006 on Registration, Evaluation, Authorization, and Restriction of Chemicals (REACH).

Conflict Materials: Atlanta Micro does not knowingly use materials that are sourced from the Democratic Republic of Congo (DRC) or any other known conflict regions. Atlanta Micro's supply chain is comprised of sources that are both environmentally and socially responsible. We periodically review this requirement with our vendors to ensure continued compliance.

Atlanta Micro takes its responsibility as a global partner seriously and will use due diligence within our supply chain to ensure all standards are met to the best of our knowledge.