

AM3257 – Filter Bank

4 to 20 GHz Bandpass Filter Bank

AM3257 is a filter bank covering the 4 GHz to 20 GHz frequency range. The filter bank contains 5 bandpass filters with full 1 GHz overlap as well as an integrated, low-loss filter bypass path. The AM3257 is an excellent front-end filter bank for a broadband receiver or transmitter. AM3257 is packaged in a 5mm QFN package and operates over the -40C to +85C temperature range.

FEATURES

- 4-20 GHz Filter
- Integrated Switches
- Integrated Control Line Filtering
- 6 dB Insertion Loss
- 20 GHz Bypass Path
- +38 dBm IIP3
- +3.3 to +5.0 V Supply
- +3.3 to +5.0 V Control
- -40 °C to +85 °C Operation
- 5mm QFN Package

FUNCTIONAL DIAGRAM

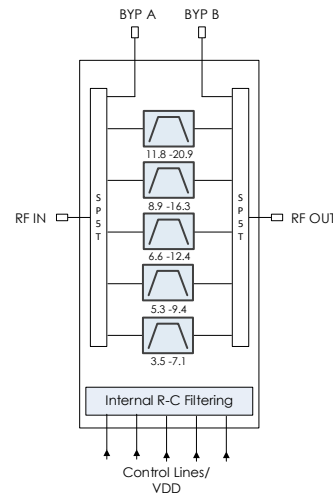

CHARACTERISTIC PERFORMANCE

Typical Frequency Response

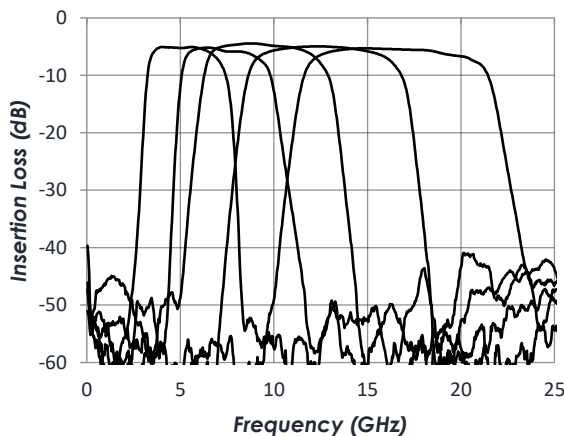

Filter Bypass

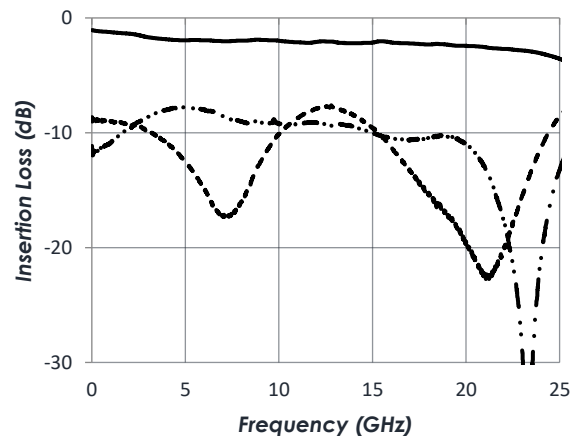

CONTENTS

REVISION HISTORY..... 2

PIN LAYOUT AND DEFINITIONS 3

SPECIFICATIONS..... 4

State Table..... 5

TYPICAL PERFORMANCE 6

TYPICAL APPLICATION..... 8

EVALUATION PC BOARD..... 9

RELATED PARTS..... 9

COMPONENT COMPLIANCE INFORMATION10

REVISION HISTORY

Date	Revision	Notes
7/17/2025	1	Initial Release
4/27/2026	1.1	Added control logic table

PIN LAYOUT AND DEFINITIONS

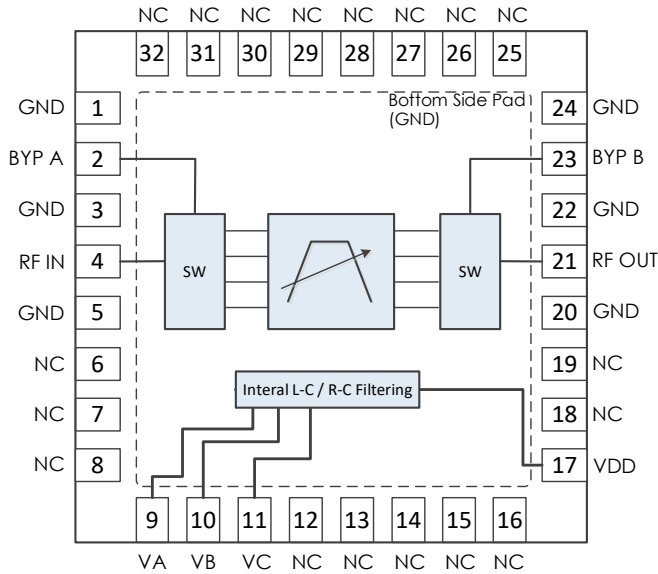

Pin	Name	Function
1	GND	Ground - Common
2	BYP A	Filter Bypass A - 50 Ohms - DC Coupled. External DC Blocking Capacitor Required.
3	GND	Ground - Common
4	RF IN	RF Input - 50 Ohms - DC Coupled. External DC Blocking Capacitor Required.
5	GND	Ground - Common
6-8	NC	Not Connected
9	VA	Switch Control A
10	VB	Switch Control B
11	VC	Switch Control C
12-16	NC	Not Connected
17	VDD	DC Power Input
18-19	NC	Not Connected
20	GND	Ground - Common
21	RF OUT	RF Output - 50 Ohms - DC Coupled. External DC Blocking Capacitor Required.
22	GND	Ground - Common
23	BYP B	Filter Bypass B - 50 Ohms - DC Coupled. External DC Blocking Capacitor Required.
24	GND	Ground - Common
25-32	NC	Not Connected

Note: NC pins may be left open or connected to GND. Mercury recommends connecting them to GND.

SPECIFICATIONS

Absolute Maximum Ratings

	Minimum	Maximum
Supply Voltage	-0.3V	+6.0V
RF Input Power		+27dBm
Storage Temperature Range	-55 C	+150 C

Note: Any device operation beyond the Absolute Maximum Ratings may result in permanent damage to the device. The values listed in this table are extremes and do not imply functional operation of the device at these or any other conditions beyond what is listed under Recommended Operating Conditions. Any part subjected to conditions outside of what is recommended for an extended amount of time may suffer from reliability concerns.

Handling Information

	Minimum	Maximum
Moisture Sensitivity Level	MSL 3	



Mercury products are electrostatic sensitive. Follow safe handling practices to avoid damage.

Recommended Operating Conditions

	Minimum	Typical	Maximum
Supply Voltage	+3.0 V	+3.3 V	+5.2 V
Operating Case Temperature	-40 °C		+85 °C

DC Electrical Characteristics

(T = 25 °C unless otherwise specified)

Param	Testing Conditions	Min	Typical	Max
DC Supply Voltage		+3.0 V	+3.3 V	+5.0 V
DC Supply Current	VDD = +3.3 V		10 mA	
Power Dissipated	VDD = +3.3 V		33 mW	

RF Performance

(T = 25 °C unless otherwise specified)

Param	Testing Conditions	Min	Typical	Max
Frequency Range		4 GHz		20 GHz
Insertion Loss	VDD = +3.3 V, Band 1		-5 dB	
	VDD = +3.3 V, Band 2		-5.5 dB	
	VDD = +3.3 V, Band 3		-5.1 dB	
	VDD = +3.3 V, Band 4		-5.8 dB	
	VDD = +3.3 V, Band 5		-4.7 dB	
Return Loss	VDD = +3.3 V		-15 dB	
Input IP3	VDD = +3.3 V		+38 dBm	

Timing Characteristics

	Minimum	Typical	Maximum
Band Switching Speed		40 ns	

Note: Timing characteristics measured from 50% control to 90% RF.

State Table

VA	VB	VC	Filter Band
L	L	L	Bypass
L	L	H	Band 1 (4.0 to 6.8 GHz)
L	H	L	Band 5 (13 to 20 GHz)
L	H	H	Band 3 (7.0 to 12 GHz)
H	L	L	Band 4 (10 to 15.5 GHz)
H	L	H	Band 2 (5.8 to 9.0 GHz)

TYPICAL PERFORMANCE

(VDD = +3.3 V, T = 25°C unless otherwise specified)

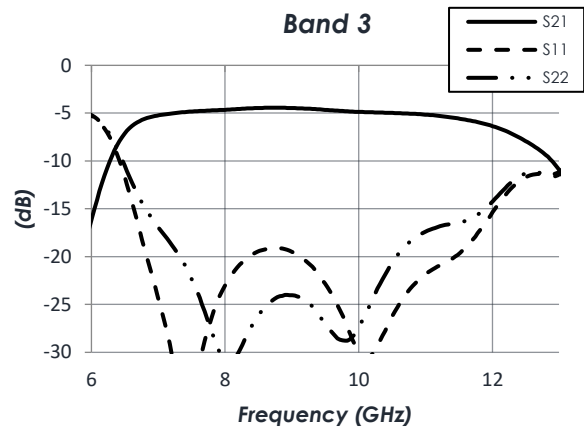
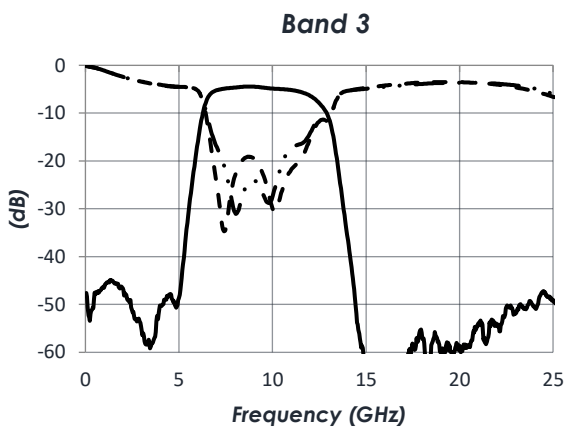
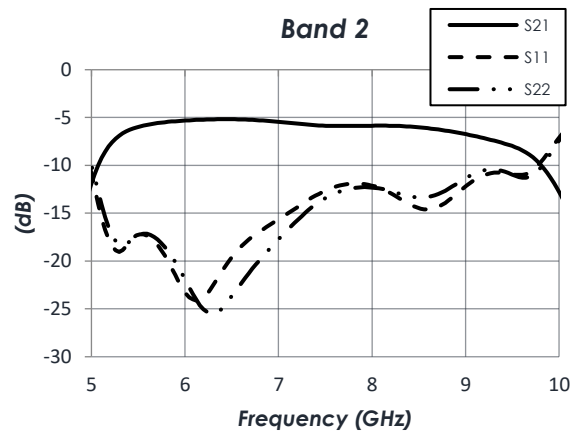
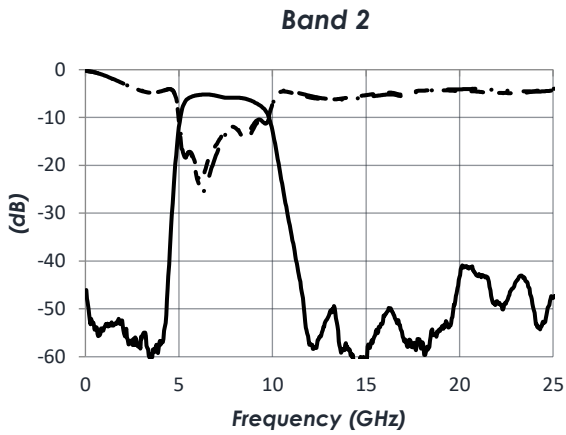
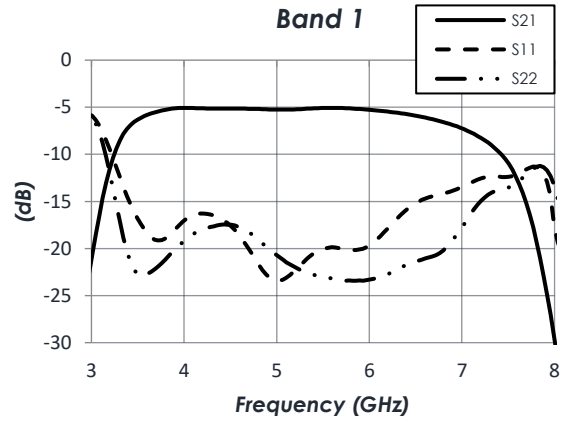
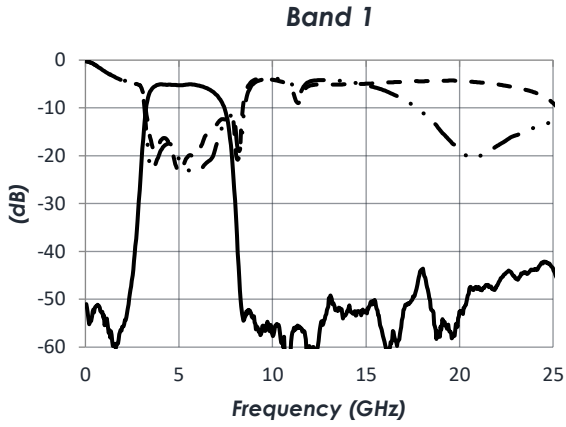

TYPICAL PERFORMANCE (CONTINUED)

(VDD = +3.3 V, T = 25°C unless otherwise specified)

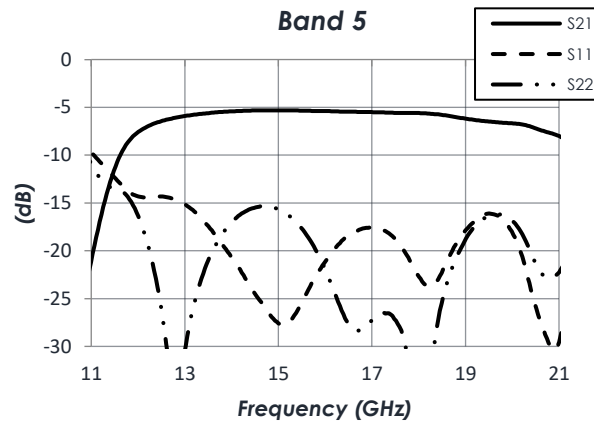
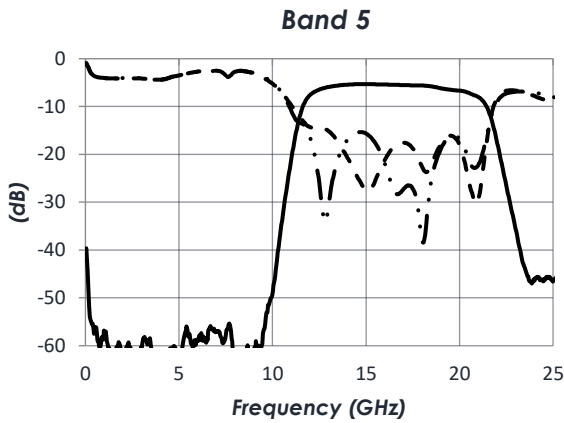
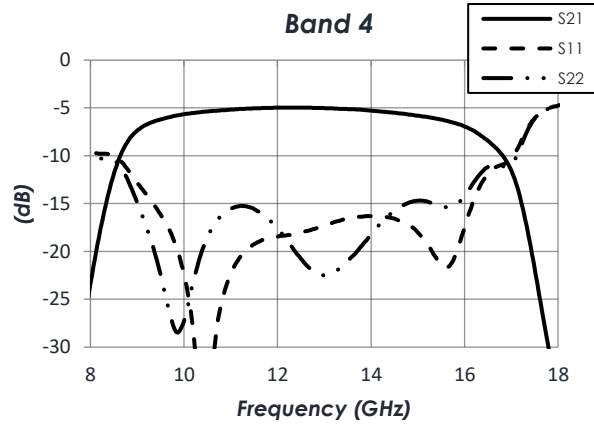
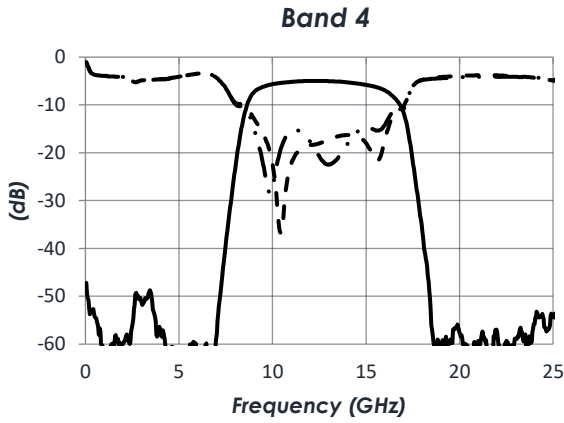

TYPICAL APPLICATION

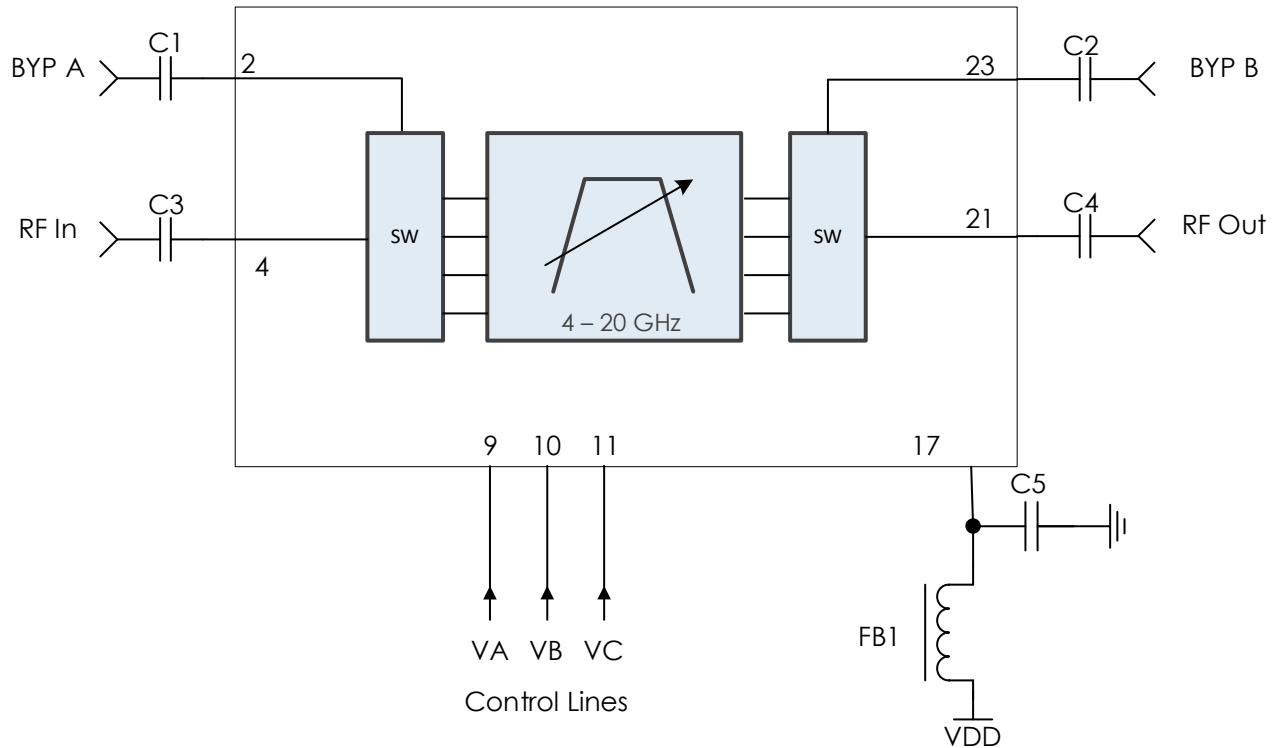

RECOMMENDED COMPONENT LIST (OR EQUIVALENT)

Part	Value	Part Number	Manufacturer
C1-C4	0.1 μ F	0201BB104KW160	Passive Plus
C5	0.1 μ F	C1005X7R1H104K050BB	TDK
FB1	-	MMZ1005A222E	TDK

Note:

1. Control lines filtered internally providing high frequency isolation.
 - a. Additional R-C Filtering may be added to control lines for additional isolation.
2. DC blocking capacitors should be low-loss, broadband capacitors for optimum performance.
3. Timing measurements were performed without any external R-C components on VA-VC and configured as shown here.

EVALUATION PC BOARD

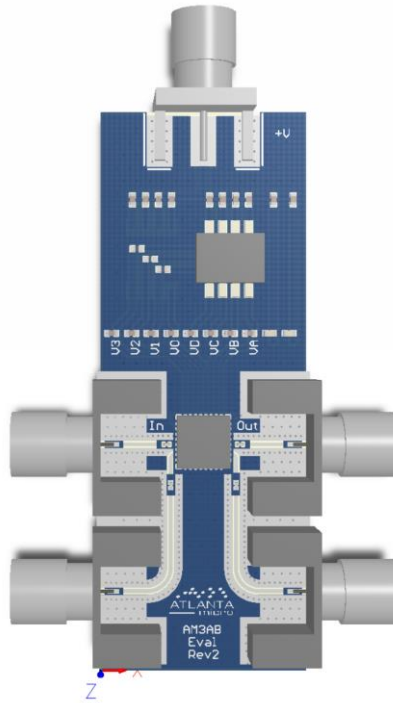

RELATED PARTS

Part Number		Description		
AM3163	2 GHz to 18 GHz	Digitally Tunable Bandpass Filter Bank		
AM3186	6 GHz to 26.5 GHz	Sub-Octave Bandpass Filter Bank		
AM3227	5 GHz to 20 GHz	Tunable Bandpass Filter Bank		
AM3275	6 GHz to 18 GHz	Tunable Bandpass Filter Bank		

COMPONENT COMPLIANCE INFORMATION

RoHS: Mercury Systems, Inc. hereby certifies that all products comply with the EC Directive 2011/65/EC on the Restriction of Hazardous Substances, commonly known as EU-RoHS 6 and 10. All products supplied by Mercury shall be compliant with the European Directive 2011/65/EC based on the following substance list.

Substance List	Allowable Maximum Concentration
Lead (Pb)	<1000 PPM (0.1% by weight)
Mercury (Hg)	<1000 PPM (0.1% by weight)
Cadmium (Cd)	<75 PPM (0.0075% by weight)
Hexavalent Chromium (CrVI)	<1000 PPM (0.1% by weight)
Polybrominated Biphenyls (PBB)	<1000 PPM (0.1% by weight)
Polybrominated Diphenyl ethers (PBDE)	<1000 PPM (0.1% by weight)
Decabromodiphenyl Deca BDE	<1000 PPM (0.1% by weight)
Bis (2-ethylhexyl) Phthalate (DEHP)	<1000 PPM (0.1% by weight)
Butyl Benzyl Phthalate (BBP)	<1000 PPM (0.1% by weight)
Dibutyl Phthalate (DBP)	<1000 PPM (0.1% by weight)
Diisobutyl Phthalate (DIBP)	<1000 PPM (0.1% by weight)

REACH: Mercury Systems, Inc. neither uses nor intentionally adds any of the substances considered to be a Substance of Very High Concern (SVHC) as defined by the EU Regulation (EC) No. 1907-2006 on Registration, Evaluation, Authorization, and Restriction of Chemicals (REACH).

Conflict Materials: Mercury does not knowingly use materials that are sourced from the Democratic Republic of Congo (DRC) or any other known conflict regions. Mercury’s supply chain is comprised of sources that are both environmentally and socially responsible. We periodically review this requirement with our vendors to ensure continued compliance.

Mercury takes its responsibility as a global partner seriously and will use due diligence within our supply chain to ensure all standards are met to the best of our knowledge.



Corporate Headquarters

50 Minuteman Road
 Andover, MA 01810 USA
 +1 978.967.1401 tel
 +1 866.627.6951 tel
 +1 978.256.3599 fax

International Headquarters

Mercury International
 Avenue Eugène-Lance, 38
 PO Box 584
 CH-1212 Grand-Lancy 1
 Geneva, Switzerland
 +41 22 884 5100 tel

Learn more

Visit: mrcy.com

For pricing details, contact: MMICsales@mrcy.com

For technical details, contact: MMICsupport@mrcy.com



The Mercury Systems logo is a registered trademark of Mercury Systems, Inc. Other marks used herein may be trademarks or registered trademarks of their respective holders. Mercury products identified in this document conform with the specifications and standards described herein. Conformance to any such standards is based solely on Mercury’s internal processes and methods. The information contained in this document is subject to change at any time without notice.

