

Surface Mount Isolator SMD1300-T0300



Specifications are subject to change without notice

Specifications (+25°C)

Parameter	Value
RF Frequency	8.5 GHz to 10.5 GHz
Isolation	18 dB (min)
Insertion Loss	0.5 dB (max)
VSWR	1.25:1
Power Forward	5 Watts
Power Reverse	1 Watts
Operating Temperature	-35 to 85°C
Package Size	0.5"

Outline Drawing

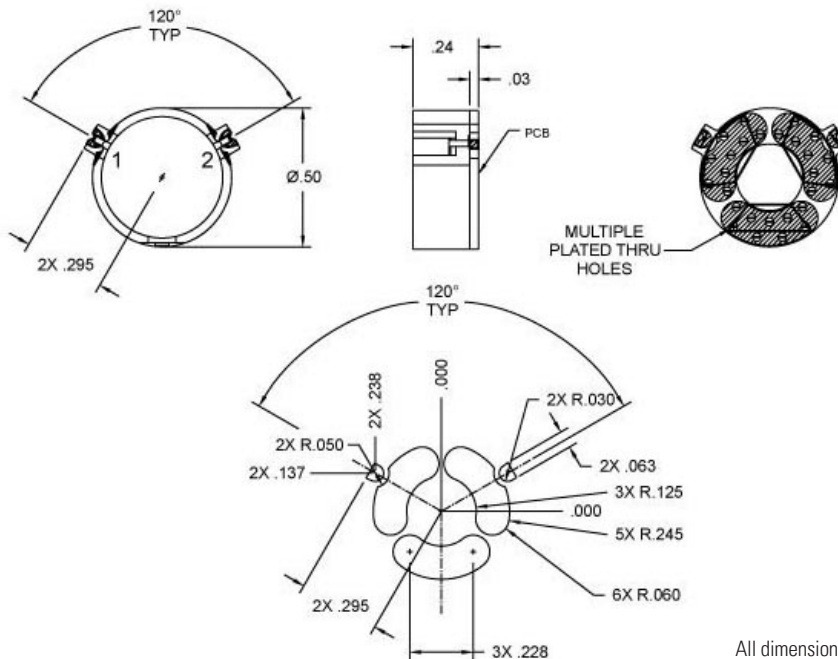

All dimensions are in inches

Need More Help? Need a Variant of This Product?

Contact Mercury's RF & Microwave engineering team at rf.microwave@mrcy.com or visit www.mrcy.com/rf for a detailed listing of RF and Microwave products.



Corporate Headquarters • 50 Minuteman Road • Andover, MA 01810 USA • (978) 967-1401 • (866) 627-6951 • Fax (978) 256-3599 • www.mrcy.com