

# Double Balanced Mixer B50V



Specifications are subject to change without notice

## Specifications

Parameter	Value
RF Frequency	5 to 18 GHz
LO Frequency	5 to 18 GHz
LO Power	16 dBm typ
Conversion Loss	6.2 dB typ, 8 dB max
IF Frequency	DC to 4 GHz
LO to RF Isolation	22 dB min, 35 dB typ
LO to IF Isolation	20 dB min, 30 dB typ
IP3 In	19 dBm typ
P1dB In	10 dBm typ
Operating Temp	-55 °C to 100 °C

## Package Styles

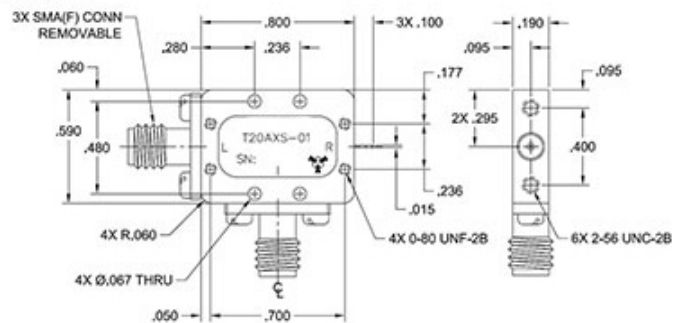
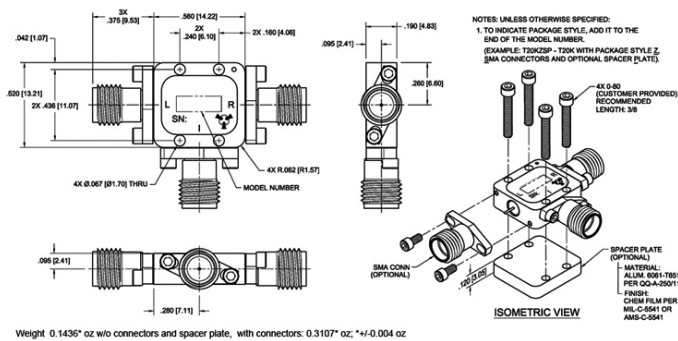
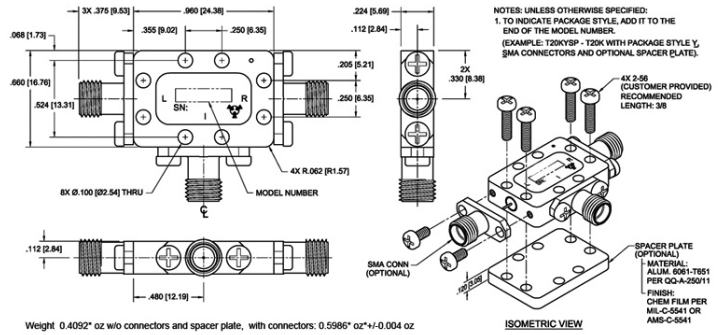
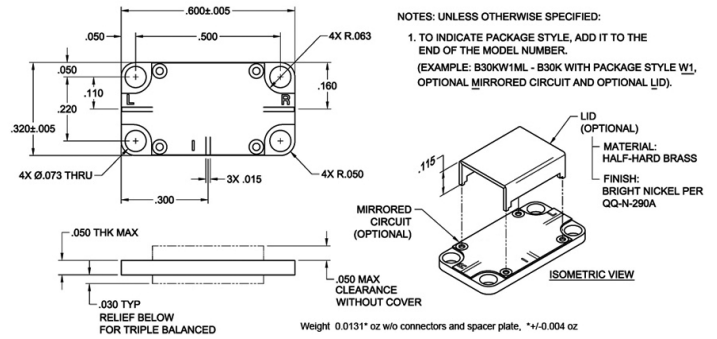

All dimensions are in inches

## Need More Help? Need a Variant of This Product?

Contact Mercury's RF & Microwave engineering team at [rf.microwave@mrcy.com](mailto:rf.microwave@mrcy.com) or visit [www.mrcy.com/rf](http://www.mrcy.com/rf) for a detailed listing of RF and Microwave products.



Corporate Headquarters • 50 Minuteman Road • Andover, MA 01810 USA • (978) 967-1401 • (866) 627-6951 • Fax (978) 256-3599 • [www.mrcy.com](http://www.mrcy.com)