

Double Balanced Mixer B90K



Specifications are subject to change without notice

Specifications

Parameter	Value
RF Frequency	9 to 16 GHz
LO Frequency	10 to 17 GHz
LO Power	10 dBm typ
Conversion Loss	5.5 dB typ, 7 dB max
IF Frequency	DC to 3 GHz
LO to RF Isolation	25 dB min, 35 dB typ
LO to IF Isolation	20 dB min, 35 dB typ
IP3 In	14 dBm typ
P1dB In	4 dBm typ
Operating Temp	-55 °C to 100 °C

Package Styles

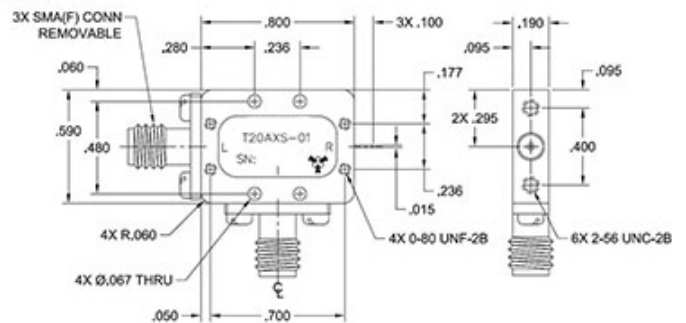
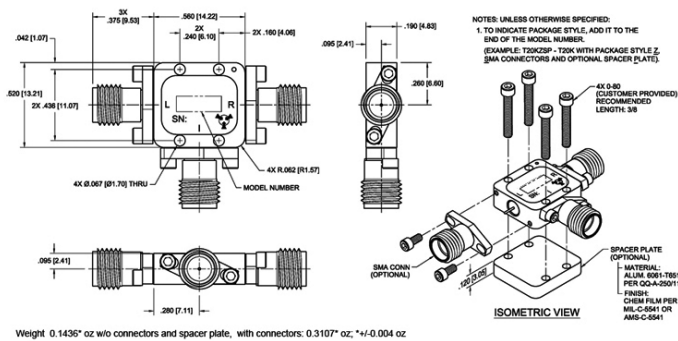
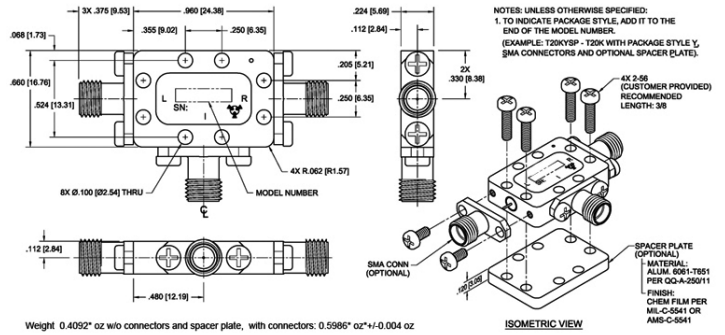
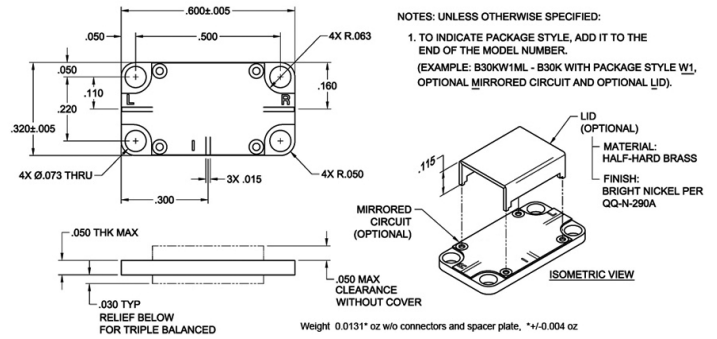

All dimensions are in inches

Need More Help? Need a Variant of This Product?

Contact Mercury's RF & Microwave engineering team at rf.microwave@mrcy.com or visit www.mrcy.com/rf for a detailed listing of RF and Microwave products.



Corporate Headquarters • 50 Minuteman Road • Andover, MA 01810 USA • (978) 967-1401 • (866) 627-6951 • Fax (978) 256-3599 • www.mrcy.com