

# Coaxial Isolator T-012S15



Specifications are subject to change without notice

## Specifications (+25°C)

Parameter	Value
RF Frequency	12.3 GHz to 13.2 GHz
Isolation	20 dB (min)
Insertion Loss	0.5 dB (max)
VSWR	1.25:1
Peak Power	10 Watts (max)
Average Power	1 Watts (max)
Package Size	0.50 x 0.56 x 0.38"

## Outline Drawing

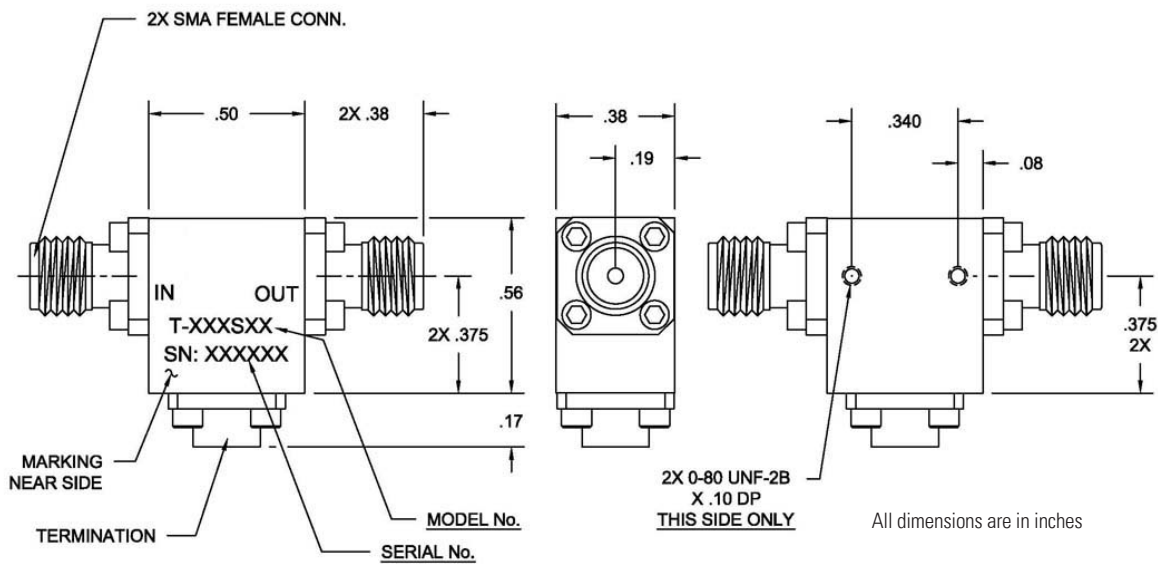

### Need More Help? Need a Variant of This Product?

Contact Mercury's RF & Microwave engineering team at [rf.microwave@mrcy.com](mailto:rf.microwave@mrcy.com) or visit [www.mrcy.com/rf](http://www.mrcy.com/rf) for a detailed listing of RF and Microwave products.



Corporate Headquarters • 50 Minuteman Road • Andover, MA 01810 USA • (978) 967-1401 • (866) 627-6951 • Fax (978) 256-3599 • [www.mrcy.com](http://www.mrcy.com)