

Coaxial Isolator T-200S03



Specifications are subject to change without notice

Specifications (+25°C)

Parameter	Value
RF Frequency	0.95 GHz to 1.225 GHz
Isolation	20 dB (min)
Insertion Loss	0.5 dB (max)
VSWR	1.25:1
Peak Power	1000 Watts (max)
Average Power	100 Watts (max)
Package Size	1.23 x 1.23 x 0.75"

Outline Drawing

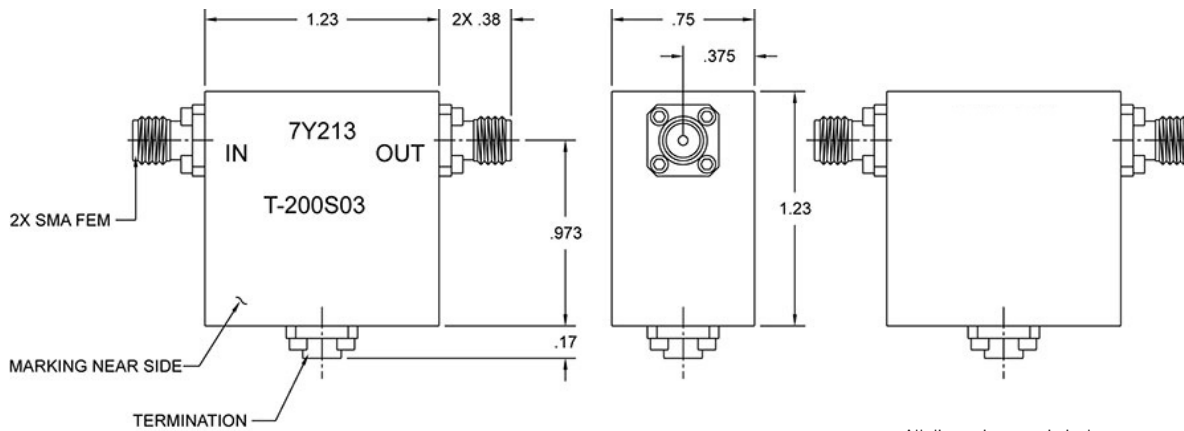

All dimensions are in inches

Need More Help? Need a Variant of This Product?

Contact Mercury's RF & Microwave engineering team at rf.microwave@mrcy.com or visit www.mrcy.com/rf for a detailed listing of RF and Microwave products.



Corporate Headquarters • 50 Minuteman Road • Andover, MA 01810 USA • (978) 967-1401 • (866) 627-6951 • Fax (978) 256-3599 • www.mrcy.com