

Coaxial Isolator T-200S06



Specifications are subject to change without notice

Specifications (+25°C)

Parameter	Value
RF Frequency	0.3 GHz to 0.4 GHz
Isolation	18 dB (min)
Insertion Loss	0.5 dB (max)
VSWR	1.3:1
Peak Power	1000 Watts (max)
Average Power	100 Watts (max)
Package Size	3.75 x 3.75 x 1.50"

Outline Drawing

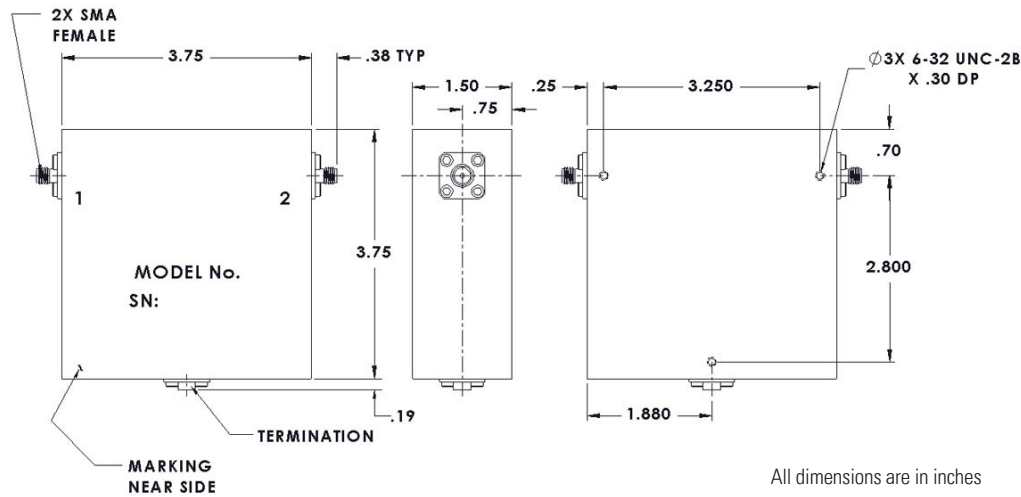

Need More Help? Need a Variant of This Product?

Contact Mercury's RF & Microwave engineering team at rf.microwave@mrcy.com or visit www.mrcy.com/rf for a detailed listing of RF and Microwave products.



Corporate Headquarters • 50 Minuteman Road • Andover, MA 01810 USA • (978) 967-1401 • (866) 627-6951 • Fax (978) 256-3599 • www.mrcy.com